

Nio 2MP / 3MP LED Display



User Guide

MDNC-3521 SNES
MDNC-2521 SNES

MDNC-3521 SPES
MDNC-2521 SPES

Barco NV

Beneluxpark 21, 8500 Kortrijk, Belgium
www.barco.com/en/support
www.barco.com

Registered office: Barco NV

President Kennedypark 35, 8500 Kortrijk, Belgium
www.barco.com/en/support
www.barco.com

Table of contents

1	Welcome!	5
1.1	What's in the box	6
1.2	At a glance	6
1.3	Compatible Barco system components	10
2	Installation and setup	11
2.1	Stand base plate mounting	12
2.2	Single workstation setup	12
2.3	Dual workstation setup with KVM switch	14
2.4	QAWeb Enterprise registration	17
2.5	VESA-mount installation	17
3	Daily operation	21
3.1	Recommendations for daily operation	22
3.2	Shortcut bar	22
3.3	On/Off switching	23
3.4	KVM input switching	23
3.5	OSD menu access and use	24
4	Advanced operation	25
4.1	OSD menu language	26
4.2	OSD menu position	26
4.3	OSD menu orientation	26
4.4	OSD menu timeout	26
4.5	Power lock function	27
4.6	DPMS mode	27
4.7	Hibernate	28
4.8	Presence sensor	28
4.9	Dry mode	29
4.10	Luminance target	29
4.11	Color temperature/white tint	30
	4.11.1 Color temperature	30
	4.11.2 Color coordinates	30
4.12	Display function	31
4.13	Ambient Light Compensation (ALC)	31
4.14	Reading room	32
4.15	Embedded QA	32

4.15.1	DICOM status report	33
4.15.2	DICOM compliance check	33
4.15.3	DICOM calibration	33
4.15.4	DICOM error threshold	34
4.15.5	Reset DICOM calibration	34
4.16	Image source	34
4.17	KVM switch	35
4.18	Grayscale conversion modes	35
4.19	System info	36
4.20	Calibration status	36
4.21	Maximum luminance demo	36
5	Cleaning the display	37
5.1	Cleaning instructions	38
6	Repackaging instructions	39
6.1	Repackaging instructions	40
7	Important information	45
7.1	Safety information	46
7.2	Cybersecurity	48
7.3	Environmental information	49
7.4	Regulatory compliance information	50
7.5	EMC notice	52
7.6	Explanation of symbols	54
7.7	Legal disclaimer	58
7.8	Open source license information	58
7.9	Technical specifications	59

Welcome!

1

1.1	What's in the box	6
1.2	At a glance.....	6
1.3	Compatible Barco system components.....	10

1.1 What's in the box

Overview

- Nio 2MP / 3MP LED Display
- Stand base plate
- Printed user guide
- Documentation disc, containing different languages of this user guide and the Barco "Display Controller and Intuitive Workflow Tools" user guide.
- System sheet
- Cables for mains, video and USB
- External power supply

If you ordered a Barco MXRT display controller, it is also in the box together with its accessories. A dedicated user guide is available on the documentation disc.



Keep your original packaging. It is designed for this display and is the ideal protection during transport and storage.



The user guides are also available on www.barco.com/support



If your product arrived with shipping damage or missing parts, please refer to the instructions in our knowledge base article '3727' at www.barco.com/support/knowledge-base/3727 for further assistance.

1.2 At a glance

Product overview

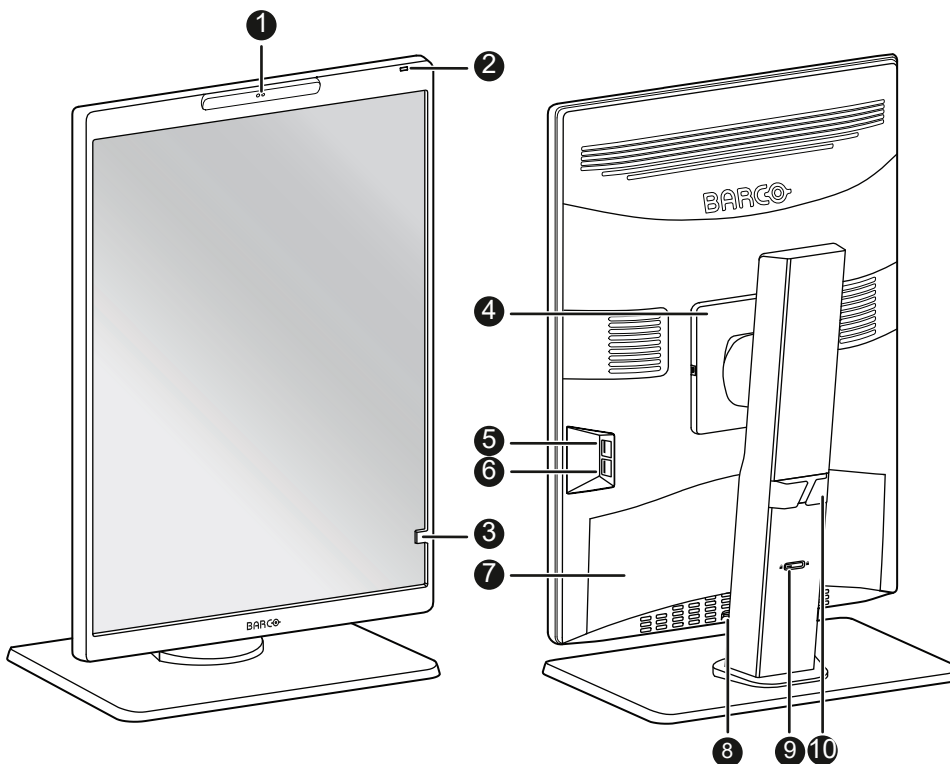

Image 1-1

1. Presence sensor

The presence sensor detects if somebody is present in front of the display (within a range of approximately 90 cm) and will set the backlight to a minimum if nobody is present after a time-out (configurable in the OSD menu). When a person is detected, the display will switch to normal operation again. See “Presence sensor”, page 28 for more information.
2. Ambient light sensor and status LED
 - Off: Display not powered (mains cable unplugged), or display is in normal operation
 - Fast blinking amber: Display is in suspend mode
 - Slow blinking amber: Display is in standby mode
 - Steady amber: Display is in hibernate mode
 - Heartbeat amber: Display manually switched off via the jog dial
3. Front sensor

CAUTION: To avoid permanent damage to the product, never use the front sensor to hold a paper, radiological film or any other object.
4. VESA mount cover
5. Side USB-A 2.0 downstream connector
6. Side USB-A 2.0 downstream connector (chargeable)¹
7. Connector cover
8. Jog dial
 - **Press:** Switch on the display, activate shortcut bar, go into (sub)menus, confirm adjustments and selections
 - **Turn left/right:** Switch on the display, activate shortcut bar, scroll through (sub) menus, change values, make selections
 - **Press and hold** for approximately 3 seconds: Switch off the display while no OSD menu is on the screen, abort DICOM compliance check/DICOM calibration
9. Stand locking mechanism
10. Cable routing channels

Connectors

Two USB connectors are available on the side of the display. To access the bottom connectors, gently pull the bottom of the connector cover away from the display.

1. Charging is only possible when DPMS mode **with** USB charging is enabled, or when DPMS is completely disabled (see “DPMS mode”, page 27).

Welcome!

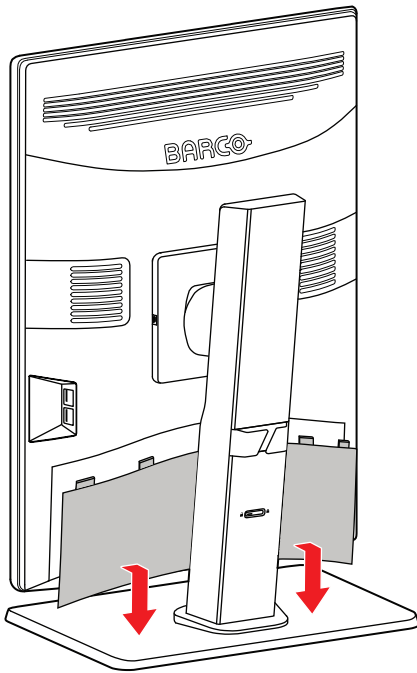

Image 1–2

Following connectors are available:

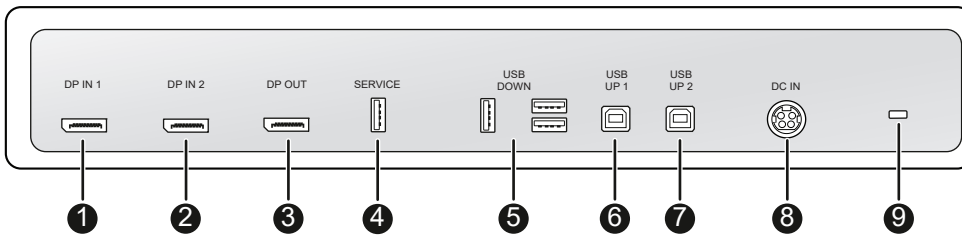

Image 1–3

1. DisplayPort IN 1 (also main for KVM switching)
2. DisplayPort IN 2 (also secondary for KVM switching)
3. DisplayPort OUT (Manufacturing test only)
4. Service (Service purpose only)
5. USB-A 2.0 downstream connectors (3x)
6. USB-B 2.0 upstream connector 1 (Main)
7. USB-B 2.0 upstream connector 2 (Secondary)
8. +24V DC mains power input
9. Kensington security slot

Display position adjustment

After unpacking, you can safely tilt, swivel and pivot the display to your preferred position.

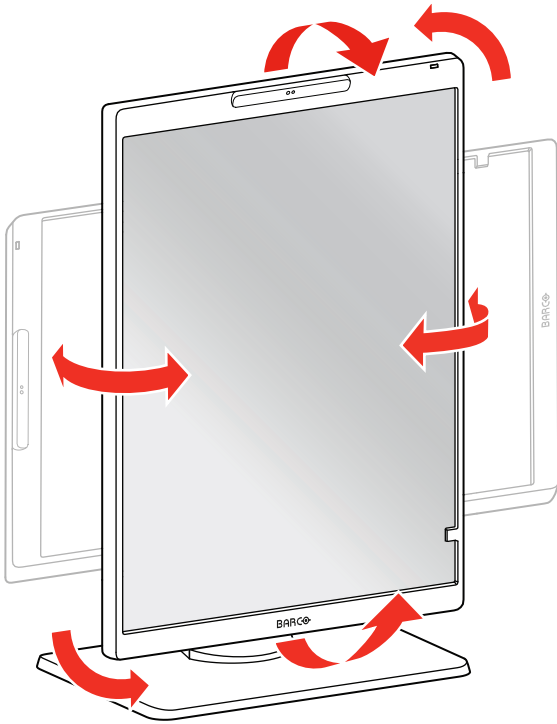

Image 1-4

To adjust the height of the display, first move the slider at the back of the stand to the **unlock** position. Then you can raise or lower the display as desired.

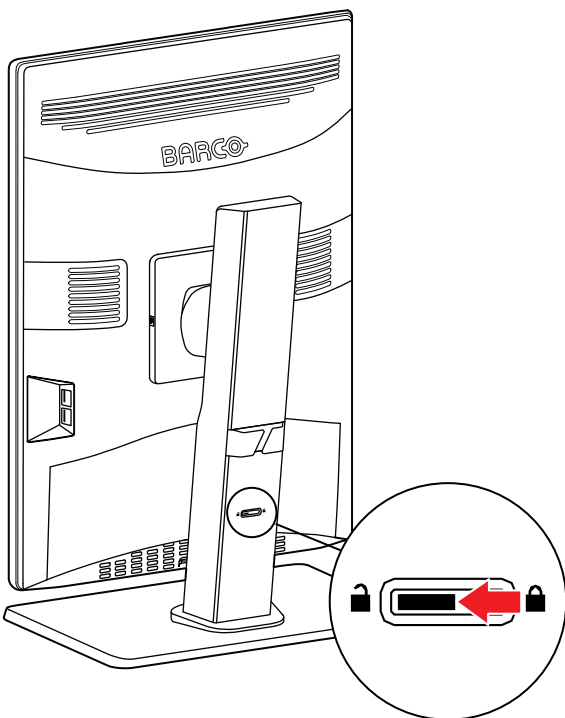

Image 1-5

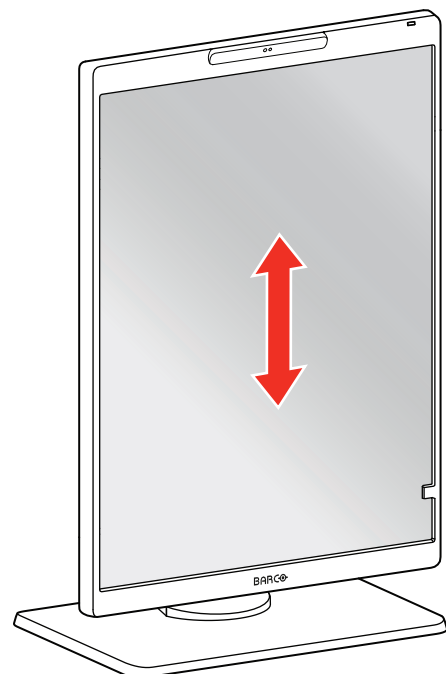

Image 1-6



The height can be locked only in the lowest position, even though the slider at the back of the stand can be moved to the lock position at any height of the display.

1.3 Compatible Barco system components

Overview

Following Barco components are compatible with your Nio 2MP / 3MP LED Display:

- QAWeb Enterprise Agent version 2.11 or later.
- QAWeb for DIN 6868-157-1.3.3 or later.
- MXRT-x700 generation display controllers.
The previous generation MXRT-x600 display controllers are also supported.
- Barco SW Pkg 2022.3 or later.

Installation and setup

2

2.1	Stand base plate mounting	12
2.2	Single workstation setup	12
2.3	Dual workstation setup with KVM switch	14
2.4	QAWeb Enterprise registration	17
2.5	VESA-mount installation	17

2.1 Stand base plate mounting

To mount the stand base plate

- Put the display face down on a clean and soft surface. Be careful not to damage the panel.
 -  *Tip:* The stand base plate can also be mounted while the display is still safely positioned in the bottom buffer of box. See [“Repackaging instructions”](#), page 40 for more information.
- Attach the stand base plate to the pillar by fixing the dedicated screw as shown below.

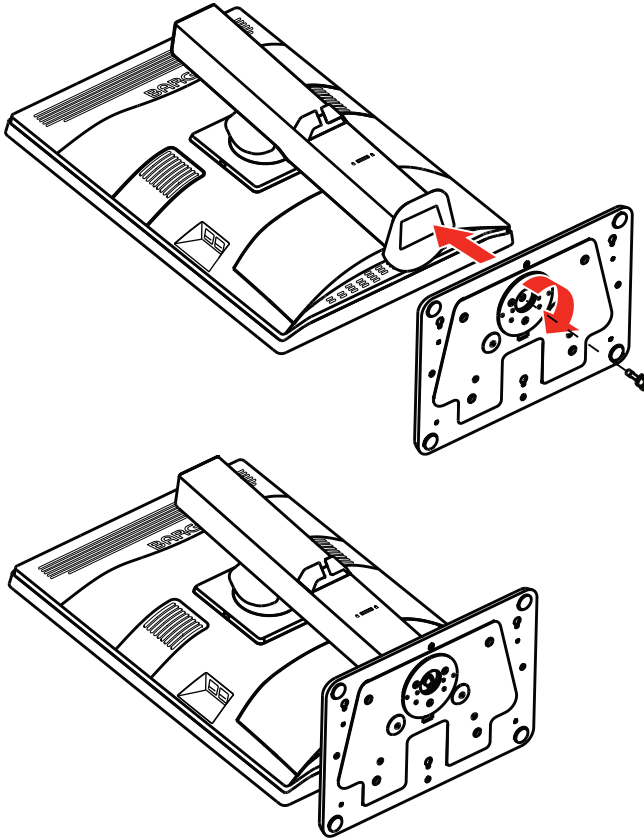

Image 2-1

2.2 Single workstation setup

About

In this setup, the display is connected to a single workstation with a DisplayPort cable. When connecting a USB cable from your display to the workstation, you can control the workstation with a keyboard and mouse connected to the display.

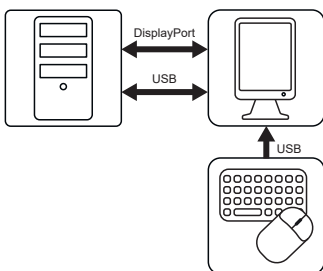

Image 2-2

Install the display controller

Before you connect your display with the workstation, make sure to have a suitable² display controller installed in the workstation.



The Nio 2MP / 3MP LED Display operates at its full specifications when driven by a Barco **MXRT display controller** and **MXRT driver**. These high-performing graphics cards have the power and features necessary to meet most diagnostic imaging needs. Moreover, Barco MXRT display controllers enable the use of Barco's **Intuitive Workflow Tools** that are designed to increase visibility of subtle details, improve focus during reading sessions, and accelerate workflow. Please visit www.barco.com/product/intuitive-workflow-tools for more information.

Connect the cables

1. Remove the connector cover.
2. Connect one of the DisplayPort inputs (DP IN 1 or DP IN 2) with the DisplayPort output on the workstation.
3. Connect the main USB upstream connectors (USB UP 1) with a USB host on the workstation to make use of QAWeb Enterprise or a peripheral (keyboard, mouse, touchpad, etc.) connected to one of the display's USB downstream connectors.
4. Connect a keyboard and mouse (or another peripheral used to control the workstations) with the USB downstream connectors of the display. Three USB downstream connectors are available in the connector compartment.



Note: When DPMS mode **with** USB charging is enabled (see "DPMS mode", page 27) and hibernate is enabled (see "Hibernate", page 28), you can easily awaken your system from hibernate with a mouse/keyboard connected to the display.
When DPMS mode **without** USB charging is enabled (see "DPMS mode", page 27) and hibernate is enabled (see "Hibernate", page 28), you can only awaken your system from hibernate by pressing the jog dial, or with a mouse/keyboard connected to the workstation (and not to the display).

5. Connect the supplied external DC power supply to the power input on the display.
6. Route all cables through the cable clips in the connector compartment.
7. Re-install the connector cover: slide the top of the cover in the available recesses, then push the bottom of the cover back into position.
8. Route all cables through the routing channels in the stand of your display.
9. Connect the external DC power supply to a grounded power outlet by using one of the power cables included with the display.

2. For a list of compatible display controllers, please refer to the compatibility matrix available on my.barco.com (MyBarco > My Support > Healthcare > Compatibility Matrices > Barco Systems Compatibility Matrices)

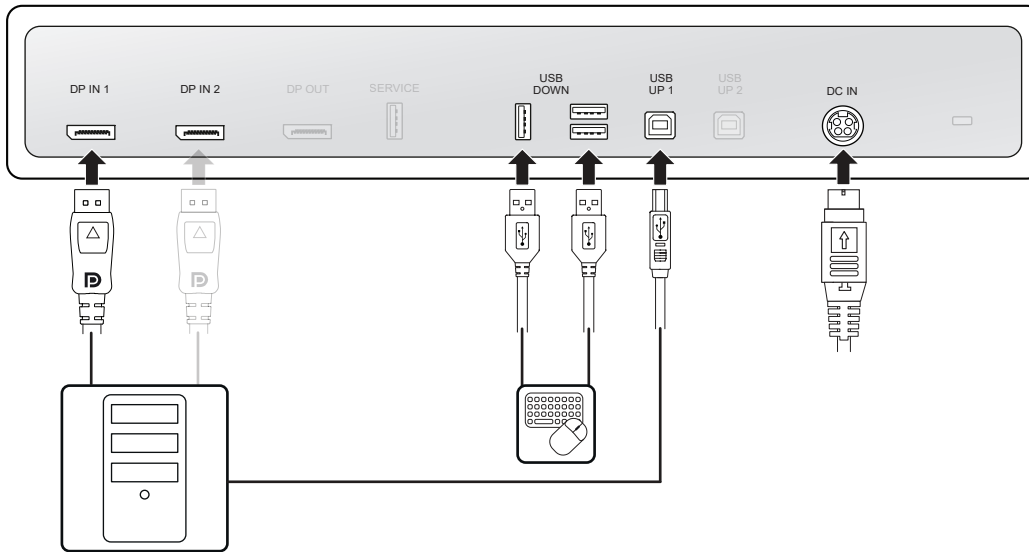

Image 2-3



To switch between different image sources, see “Image source”, page 34 for more information.

Power on the display system

1. Press/Turn the jog dial to activate your display.
2. Switch on the workstations connected to your display.

Your display will be running in a basic video mode at a default refresh rate when first time starting up.

Install the MXRT driver and Intuitive Workflow Tools

When using a Barco MXRT display controller, install the **MXRT driver** and **Intuitive Workflow Tools** on the connected workstation. Barco’s Intuitive Workflow Tools are designed to increase visibility of subtle details, improve focus during reading sessions, and accelerate workflow.

1. Download the latest MXRT driver and Intuitive Workflow Tools from www.barco.com/mxrt.
2. Install the MXRT driver and Intuitive Workflow Tools as described in the Barco “Display Controller and Intuitive Workflow Tools” user guide on the included documentation CD, or at www.barco.com/support.

2.3 Dual workstation setup with KVM switch

About

In this setup, the display is connected to two different workstations, each with one DisplayPort cable. When connecting a USB cable from your display to each of the two workstations, you can control both workstations with a single keyboard and mouse connected to the display. Switching the video and control signals between the two workstations is done with the KVM switch operated via the OSD menu.

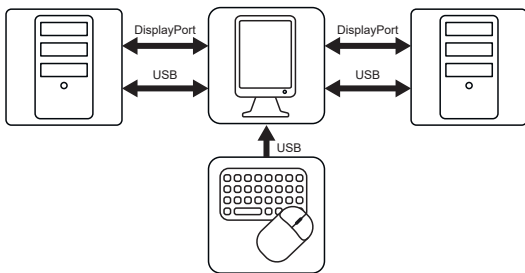

Image 2-4



Barco suggests to have QAWeb Enterprise installed on only one of both workstations. When both workstation would have QAWeb Enterprise installed, switching KVM inputs would trigger a Configuration Change event, causing the display to disappear from the workstation in QAWeb Enterprise.

Install the display controller

Before you connect your display with the workstation, make sure to have a suitable³ display controller installed in the workstation.



The Nio 2MP / 3MP LED Display operates at its full specifications when driven by a Barco **MXRT display controller** and **MXRT driver**. These high-performing graphics cards have the power and features necessary to meet most diagnostic imaging needs. Moreover, Barco MXRT display controllers enable the use of Barco's **Intuitive Workflow Tools** that are designed to increase visibility of subtle details, improve focus during reading sessions, and accelerate workflow. Please visit www.barco.com/product/intuitive-workflow-tools for more information.

Connect the cables

1. Remove the connector cover.
2. Connect DisplayPort input 1 (DP IN 1) with the DisplayPort output on workstation 1.
3. Connect the main USB upstream connector (USB UP 1) with a USB host on workstation 1.
4. Connect DisplayPort input 2 (DP IN 2) with the DisplayPort output on workstation 2.
5. Connect the secondary USB upstream connector (USB UP 2) with a USB host on workstation 2.
6. Connect a keyboard and mouse (or another peripheral used to control the workstations) with the USB downstream connectors of the display. Three USB downstream connectors are available in the connector compartment.
 -  **Note:** When DPMS mode **with** USB charging is enabled (see “DPMS mode”, page 27) and hibernate is enabled (see “Hibernate”, page 28), you can easily awaken your system from hibernate with a mouse/keyboard connected to the display. When DPMS mode **without** USB charging is enabled (see “DPMS mode”, page 27) and hibernate is enabled (see “Hibernate”, page 28), you can only awaken your system from hibernate by pressing the jog dial, or with a mouse/keyboard connected to the workstation (and not to the display).
7. Connect the supplied external DC power supply to the power input on the display.
8. Route all cables through the cable clips in the connector compartment.
9. Re-install the connector cover: slide the top of the cover in the available recesses, then push the bottom of the cover back into position.
10. Route some or all cables through the routing channels in the stand of your display.
11. Connect the external DC power supply to a grounded power outlet by using one of the power cables included with the display.

3. For a list of compatible display controllers, please refer to the compatibility matrix available on my.barco.com (MyBarco > My Support > Healthcare > Compatibility Matrices > Barco Systems Compatibility Matrices)

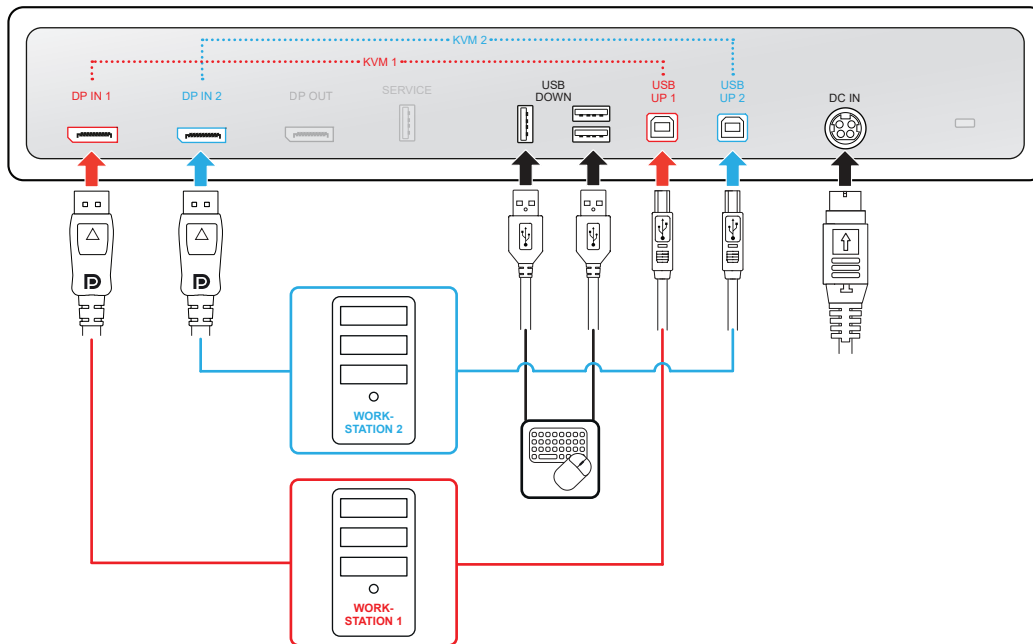

Image 2-5

Power on the display system

1. Press/Turn the jog dial to activate your display.
2. Switch on the workstations connected to your display.

Your display will be running in a basic video mode at a default refresh rate when first time starting up.

Install the MXRT driver and Intuitive Workflow Tools

When using a Barco MXRT display controller, install the **MXRT driver** and **Intuitive Workflow Tools** on the connected workstation. Barco's Intuitive Workflow Tools are designed to increase visibility of subtle details, improve focus during reading sessions, and accelerate workflow.

1. Download the latest MXRT driver and Intuitive Workflow Tools from www.barco.com/mxrt.
2. Install the MXRT driver and Intuitive Workflow Tools as described in the Barco "Display Controller and Intuitive Workflow Tools" user guide on the included documentation CD, or at www.barco.com/support.

Enable the KVM switch

1. Bring up the OSD main menu.
2. Navigate to the *Image Settings* menu.
3. Enter the *KVM Switch* submenu.
4. Select *Enabled* and confirm.



When enabling the KVM switch, the *Image Source* menu will be inaccessible.

To switch KVM inputs

1. Press or turn the jog dial to activate the shortcut bar. The KVM switch icon () is now selected by default because the KVM switch is enabled.
2. Press the jog dial again to switch KVM inputs.



During normal operation, double-press the jog dial to switch KVM inputs more quickly. A first click will make the shortcut bar pop up, a second click will switch inputs (since the KVM switch icon is selected by default when the KVM switch is enabled).



When switching KVM inputs, the video is switched instantly while switching the USB signal might take a little longer (up to 2 seconds).

2.4 QAWeb Enterprise registration

About

QAWeb Enterprise helps you manage quality and assure compliance of your expanding healthcare enterprise with less effort, lower cost, and complete confidence. This fully automated and secure system supports a consistent image quality and uptime for all registered imaging display systems within your facility and across your enterprise. Learn more at www.barco.com/qaweb.

To register your display system to your QAWeb Enterprise organization, the QAWeb Enterprise Agent must be installed and running on your workstation and it must be able to communicate with the QAWeb Enterprise cloud service.

For more information and installation instructions, please check the QAWeb Enterprise user guide on www.barco.com/support.

2.5 VESA-mount installation



CAUTION: Use suitable mounting apparatus to avoid risk of injury.



WARNING: Never move a display attached to an arm by pulling or pushing the display itself. Instead, make sure that the arm is equipped with a VESA compliant handle and use this to move the display.

Please refer to the instruction manual of the arm for more information and instructions.



WARNING: Use a mount that is compliant with the VESA 100 mm standard.

Use a mount that can support the weight of the display. Refer to the technical specifications of this display for the applicable weight.

Overview

The panel, standard attached to a stand, is compatible with the VESA 100 mm standard. Thus, it can be used with a mount that is compliant to the VESA 100 mm standard. This chapter shows you how to release the panel from the stand and how to attach it to a VESA mount. If you're not using a mount, you can skip this chapter.

1. Unlock the stand locking mechanism and put the display in the highest position.

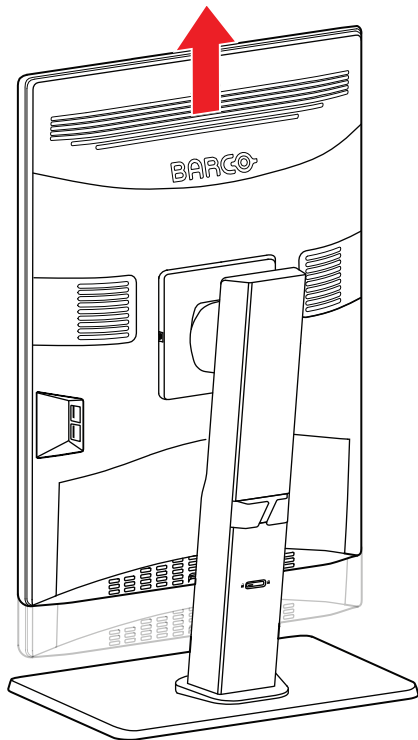

Image 2-6

2. Put the display face down on a clean and soft horizontal surface. Be careful not to damage the panel screen.
3. Push a flathead screwdriver into the right VESA mount cover hole to unlock the cover, then lift the cover with the flathead screwdriver.

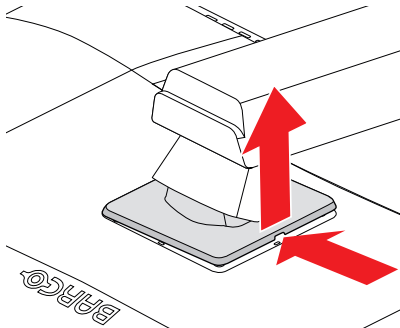

Image 2-7

4. Push a flathead screwdriver into the left VESA mount cover hole to unlock the cover, then lift the cover with the flathead screwdriver.

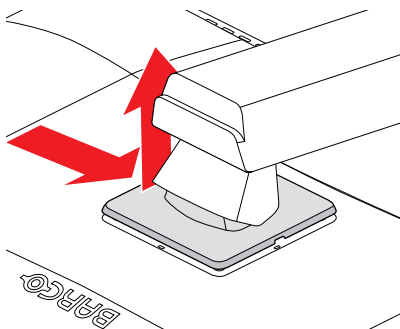

Image 2-8

5. Rotate the VESA mount cover to uncover the screws fixing the panel to the stand.

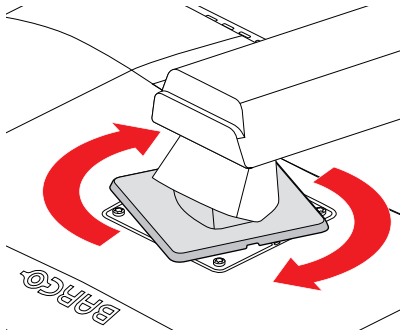

Image 2-9

6. Unscrew the 4 fixation screws while supporting the stand.

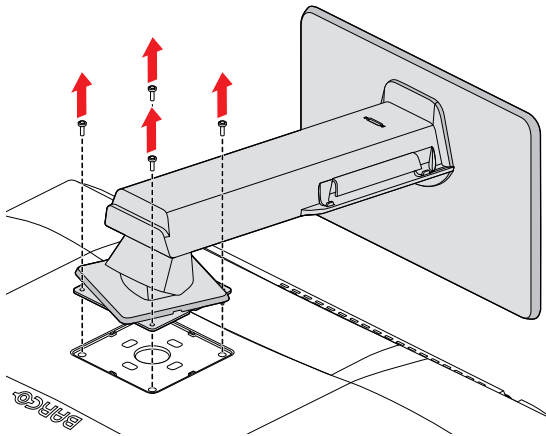

Image 2-10

7. Attach the panel **firmly** to the VESA mount using 4 M4 screws. Respect the following rule to select an appropriate screw length:

- $L_{\min} = T + W + 10\text{mm}$
- $L_{\max} = T + W + 12\text{mm}$

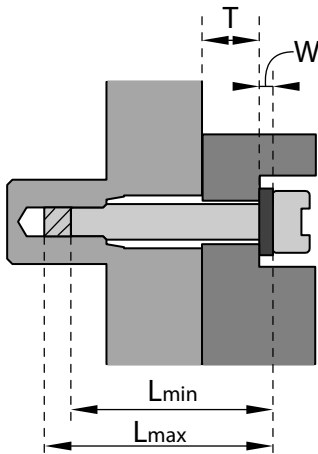

Image 2-11

Daily operation

3

3.1	Recommendations for daily operation	22
3.2	Shortcut bar	22
3.3	On/Off switching	23
3.4	KVM input switching	23
3.5	OSD menu access and use	24

3.1 Recommendations for daily operation

Optimize the lifetime of your display

Enabling the Display Power Management System (DPMS) of your display will optimize its diagnostic lifetime by automatically switching off the backlight when the display is not used for a specified period of time. By default, DPMS is enabled on your display, but it also needs to be activated on your workstation. To do this, go to the “Power Options” of your workstation.



Barco recommends setting DPMS activation after 30 minutes of non-usage.

Use a screen saver to avoid image retention

Prolonged operation of an LCD with the same content on the same screen area may result in a form of image retention.

You can avoid or significantly reduce the occurrence of this phenomenon by using a screen saver. You can activate a screen saver in the “Display properties” window of your workstation.



Barco recommends setting screen saver activation after 5 minutes of non-usage. A good screen saver displays moving content.

In case you are working with the same image or an application with static image elements for several hours continuously (so that the screen saver is not activated), change the image content regularly to avoid image retention of the static elements.

Understand pixel technology

LCD displays use technology based on pixels. As a normal tolerance in the manufacturing of the LCD, a limited number of these pixels may remain either dark or permanently lit, without affecting the diagnostic performance of the product. To ensure optimal product quality, Barco applies strict selection criteria for its LCD panels.

Enhance user comfort

Every Barco multi-head display system is color matched to the tightest specifications in the market.



Barco recommends keeping color-matched displays together. Furthermore, it is important to use all displays of a multi-head configuration at the same rate to preserve color matching throughout the economic lifetime of the system.

Maximize quality assurance

QAWeb Enterprise helps you manage quality and assure compliance of your expanding healthcare enterprise with less effort, lower cost, and complete confidence. This fully automated and secure system supports a consistent image quality and uptime for all registered PACS display systems within your facility and across your enterprise.



Barco highly recommends to use QAWeb Enterprise. Learn more at www.barco.com/qaweb.

3.2 Shortcut bar

About the shortcut bar

The shortcut bar gives direct access to a number of OSD menu functions without having to browse the OSD menu. The orientation of the shortcut bar can be adjusted to landscape/portrait via the OSD menu.

- “On/Off switching”, page 23

- “KVM input switching”, page 23
- “OSD menu access and use”, page 24



Image 3-1

To activate a shortcut bar function

1. During normal operation, press or turn the jog dial. The shortcut bar is activated.
2. Turn the jog dial left or right to select a function.
3. Press the jog dial to confirm your selection and to activate the function.

3.3 On/Off switching

To switch on your display

Press/Turn the jog dial to activate your display.

To switch off your display

1. Press/Turn the jog dial to activate the shortcut bar.
2. Turn the jog dial and select the standby icon ().
3. Press the jog dial to confirm your selection.
4. Press the jog dial again to switch off the display.

3.4 KVM input switching

About the KVM switch

The Nio 2MP / 3MP LED Display can be used in dual workstation setup with KVM switch. This allows the display to be connected to two different workstations and control both with a single keyboard and mouse connected to the display. Switching the video and control signals between the two workstations is done with the KVM switch operated via the OSD menu.



Your display system must be specifically set up and configured for KVM input switching. For instructions, see “Dual workstation setup with KVM switch”, page 14.

To switch KVM inputs

1. Press or turn the jog dial to activate the shortcut bar. The KVM switch icon () is selected by default when the KVM switch is enabled.
2. Press the jog dial again to switch KVM inputs.



During normal operation, double-press the jogdial to switch KVM inputs more quickly. A first click will make the shortcut bar pop up, a second click will switch inputs (since the KVM switch icon is selected by default when the KVM switch is enabled).



When switching KVM inputs, the video is switched instantly while switching the USB signal might take a little longer (up to 2 seconds).

3.5 OSD menu access and use

About the OSD menu

The OSD menu allows you to configure different settings to make your Nio 2MP / 3MP LED Display fit your needs within your working environment. Also, you can retrieve general information about your display and its current configuration settings through the OSD menu.

To access the OSD menu

1. Press/Turn the jog dial to activate the shortcut bar.
2. Turn the jog dial and select the OSD menu icon ()
3. Press the jog dial to enter the OSD menu.

To navigate through the OSD menus

- Turn the jog dial left/right to scroll through the (sub)menus, to change values or to make selections.
- Press the jog dial to go into a submenu or confirm adjustments and selections.
- Press and hold the jog dial for approximately 3 seconds to switch off the display while no OSD menu is on the screen or to abort DICOM compliance check/DICOM calibration.
- Turn the jog dial on *Back/Exit* and press to exit the (sub)menu.

Advanced operation

4

4.1	OSD menu language	26
4.2	OSD menu position.....	26
4.3	OSD menu orientation.....	26
4.4	OSD menu timeout	26
4.5	Power lock function.....	27
4.6	DPMS mode.....	27
4.7	Hibernate	28
4.8	Presence sensor	28
4.9	Dry mode	29
4.10	Luminance target.....	29
4.11	Color temperature/white tint.....	30
4.12	Display function	31
4.13	Ambient Light Compensation (ALC)	31
4.14	Reading room	32
4.15	Embedded QA.....	32
4.16	Image source	34
4.17	KVM switch	35
4.18	Grayscale conversion modes.....	35
4.19	System info	36
4.20	Calibration status.....	36
4.21	Maximum luminance demo.....	36

About

This section describes all settings available in the OSD menu and how to change and configure them.



Certain OSD menu settings affecting calibration can be managed by QAWeb Enterprise. Manually changing these settings in the OSD menu is still possible but the changes will be overwritten at each sync with QAWeb Enterprise.

4.1 OSD menu language

About OSD menu language

By default, the OSD menu comes up in English. However, there's a wide range of other languages available for the OSD menu of your Nio 2MP / 3MP LED Display.

To change the OSD menu language

1. Bring up the OSD main menu.
2. Navigate to the *Language* menu.
3. Select a desired language and confirm.

4.2 OSD menu position

About OSD menu position

The available OSD menu position for your display are:

- Center
- Up left
- Up right
- Bottom left
- Bottom right

To adjust the OSD menu position

1. Bring up the OSD main menu.
2. Navigate to the *OSD Settings* menu.
3. Enter the *OSD Position* submenu.
4. Select a desired OSD position and confirm.

4.3 OSD menu orientation

About OSD menu orientation

The orientation of the OSD menu (including shortcut bar) can be set to landscape or portrait. This is useful when your display is in another orientation.

To adjust the OSD menu orientation

1. Bring up the OSD main menu.
2. Navigate to the *OSD Settings* menu.
3. Enter the *OSD Orientation* submenu.
4. Select *Landscape* or *Portrait* and confirm.

4.4 OSD menu timeout

About OSD menu timeout

The OSD menu will disappear automatically after approximately 15secs of inactivity when this function is enabled. However, this function can also be disabled so that the OSD menu remains on the screen until manually closed.

To set the OSD menu timeout

1. Bring up the OSD main menu.
2. Navigate to the *OSD Settings* menu.
3. Enter the *OSD Timeout* submenu.
4. Select *Enabled/Disabled* as desired and confirm.

4.5 Power lock function

About power lock function

When the power lock function is enabled, it is no longer possible to switch off your display via the jog dial as described in [“On/Off switching”, page 23](#). DPMS mode is not affected by this setting.

To enable/disable the power lock function

1. Bring up the OSD main menu.
2. Navigate to the *Power Management* menu.
3. Enter *Power Lock* submenu.
4. Select *Enabled/Disabled* as desired and confirm.

4.6 DPMS mode

About DPMS mode

Enabling the Display Power Management System (DPMS) mode on your display will optimize its diagnostic lifetime by automatically switching off the backlight when the display is not used for a specified period of time. By default, DPMS mode is enabled on your display, but it also needs to be activated on your workstation. To do this, go to the “Power options” of your workstation.



Barco recommends setting DPMS on your workstation to activate after 30 minutes of non-usage.



When DPMS mode is enabled, three additional functions become available: hibernate, presence sensor and dry mode. See [“Hibernate”, page 28](#), [“Presence sensor”, page 28](#), [“Dry mode”, page 29](#) for more information.



When DPMS mode **with** USB charging is enabled (see [“DPMS mode”, page 27](#)) and hibernate is enabled (see [“Hibernate”, page 28](#)), you can easily awaken your system from hibernate with a mouse/keyboard connected to the display.
When DPMS mode **without** USB charging is enabled (see [“DPMS mode”, page 27](#)) and hibernate is enabled (see [“Hibernate”, page 28](#)), you can only awaken your system from hibernate by pressing the jog dial, or with a mouse/keyboard connected to the workstation (and not to the display).

To enable/disable DPMS mode on your display

1. Bring up the OSD main menu.
2. Navigate to the *Power Management* menu.
3. Enter the *DPMS Mode* submenu.
4. Select *Disabled, USB Charging Enabled or USB Charging Disabled* as desired and confirm.

4.7 Hibernate

About hibernate

When hibernate is enabled, not only the backlight, but also other functions will be disabled to reduce power consumption to a minimum. This happens after an adjustable time-out.



DPMS mode must be enabled before hibernate can be enabled. See “DPMS mode”, page 27.



When DPMS mode **with** USB charging is enabled (see “DPMS mode”, page 27) and hibernate is enabled (see “Hibernate”, page 28), you can easily awaken your system from hibernate with a mouse/keyboard connected to the display.

When DPMS mode **without** USB charging is enabled (see “DPMS mode”, page 27) and hibernate is enabled (see “Hibernate”, page 28), you can only awaken your system from hibernate by pressing the jog dial, or with a mouse/keyboard connected to the workstation (and not to the display).

To enable/disable hibernate

1. Bring up the OSD main menu.
2. Navigate to the *Power Management* menu.
3. Enter the *Hibernate* submenu.
4. Select *Enabled/Disabled* as desired and confirm.

To adjust the hibernate time-out

1. Bring up the OSD menu.
2. Navigate to the *Power Management* menu.
3. Enter the *Hibernate Timeout* submenu.
4. Set the time-out value as desired and confirm.

4.8 Presence sensor

About presence sensor

The presence sensor detects if somebody is present in front of the display (within a range of approximately 90 cm) and will set the backlight to a minimum if nobody is present after a time-out (configurable in the OSD menu by the presence sensor timer). When a person is detected, the display will switch to normal operation again.



The presence sensor cannot distinguish the difference between a person and an object. This means that for instance, a high chair might also be detected and could prevent the backlight to be set to a minimum.



Changing the display position (height, tilt, swivel or pivot) might influence the detection range of the presence sensor.



DPMS mode must be enabled before presence sensor can be enabled. See “DPMS mode”, page 27.

To enable/disable the presence sensor

1. Bring up the OSD main menu.
2. Navigate to the *Power Management* menu.

3. Enter the *Presence Sensor(PS)* submenu.
4. Select *Enabled/Disabled* as desired and confirm.

To adjust the presence sensor timer

1. Bring up the OSD main menu.
2. Navigate to the *Power Management* menu.
3. Enter the *PS Timer* submenu.
4. Set the presence sensor timer value as desired and confirm.

4.9 Dry mode

About dry mode

Dry mode prevents condensation from forming in the display. When the display enters power saving mode (hibernate), the backlight will remain powered at a minimum level to maintain some heat in the panel when dry mode is enabled.



DPMS mode must be enabled before dry mode can be enabled. See “DPMS mode”, page 27.



Dry mode is available on MDNC-2521 SPES and MDNC-3521 SPES versions only.

To enable/disable dry mode on your display:

1. Bring up the OSD main menu.
2. Navigate to the *Power Management* menu.
3. Enter the *Dry Mode* submenu.
4. Select *Enabled/Disabled* as desired and confirm.

4.10 Luminance target

About luminance target

The luminance target of your Nio 2MP / 3MP LED Display is adjustable over a predefined range. When you change the luminance target, the display will adjust its backlight to reach the target.

To set the luminance target

1. Bring up the OSD main menu.
2. Navigate to the *Image Settings* menu.
3. Enter the *Luminance Target* submenu.
4. Set the luminance target value as desired and confirm.



The default, factory calibrated luminance value is available in the technical specifications table. The guaranteed backlight lifetime is valid for this setting.

4.11 Color temperature/white tint

About color temperature/white tint

The available color temperature/white tint settings for your display are:

- **Native White:** The native, unmodified color temperature of the LCD panel
- **Clear base:** Simulation of the clearbase film color temperature
- **Blue base:** Simulation of the bluebase film color temperature
- **6500K:** Corresponds to a color temperature of 6500 Kelvin (D65)
- **User:** When selecting the User color preset, you will be able to manually define:
 - Color temperature (Kelvin)
 - Color coordinates (x, y)

To select a color temperature/white tint

1. Bring up the OSD main menu.
2. Navigate to the *Image Settings* menu.
3. Enter the *Color Temperature/White Tint* submenu.
4. Select a desired color temperature/white tint and confirm.

4.11.1 Color temperature

About color temperature

It is possible to change the color temperature of your display.



Color temperature can only be changed when the color temperature/white tint is set to *User*.

To change the color temperature

1. Bring up the OSD main menu.
2. Navigate to the *Image Settings* menu.
3. Enter the *Color Temperature/White Tint* submenu.
4. Select *User* and confirm.
5. Enter ... to bring up the color definition menu.
6. Enter the *Color Definition* menu, select *Color Temperature* and confirm.
7. Return to the *Color Temperature* menu.
8. Enter the *Color Temperature* menu.
9. Enter the *Color Temperature* submenu, set the value as desired and confirm.

4.11.2 Color coordinates

About color coordinates

It is possible to change the color coordinates of your display.



Color coordinates can only be changed when the color temperature/white tint is set to *User*.

To change the color coordinates

1. Bring up the OSD main menu.
2. Navigate to the *Image Settings* menu.
3. Enter the *Color Temperature/White Tint* submenu.
4. Select *User* and confirm.
5. Enter ... to bring up the color definition menu.
6. Enter the *Color Definition* menu, select *Color Coordinates* and confirm.

7. Return to the *Color Coordinates* menu.
8. Enter the *Color Coordinates* menu.
9. Enter the *x* and *y* submenus, set the values as desired and confirm.

4.12 Display function

About display function

Native, uncorrected panels will display all grayscale/color levels with luminance increments that are not optimal for crucial diagnostic information. Studies have shown however, that in medical images certain grayscale/color parts contain more diagnostic information than others. To respond to these conclusions, display functions have been defined. These functions emphasize on these parts containing crucial diagnostic information by correcting the native panel behavior.

The available display functions for your display are:

- **Native:** The native display panel behavior will not be corrected.
- **sRGB:** The sRGB display function is designed to match typical home and office viewing conditions. It is widely used in most computer applications.
- **Dynamic Gamma 1.8 or 2.2:** These are gamma functions that are shifted to take into account the non-zero luminance of an LCD panel when driven with a “black” signal. They are especially useful in CT applications to improve the perception of low Hounsfield values.
- **DICOM:** DICOM (Digital Imaging and Communications in Medicine) is an international standard that was developed to improve the quality and communication of digital images in radiology. In short, the DICOM display function results in more visible grayscales in the images. Barco recommends selecting the DICOM display function for most medical viewing applications.
- **User Calibration:** This display function will be automatically selected when display functions are defined by QAWeb Enterprise.
- **Gamma 1.8 or 2.2:** Select one of these display functions in case the display is to replace a CRT display with a gamma of 1.8 or 2.2 respectively.
- **Test:** For Barco service purposes only.



The settings of the display must be adapted to suit the requirements of the visualization software. In case of doubt, please contact the vendor of the visualization software.

To select a display function

1. Bring up the OSD main menu.
2. Navigate to the *Image Settings* menu.
3. Enter the *Display Function* submenu.
4. Select a desired display function and confirm.

4.13 Ambient Light Compensation (ALC)

About ALC



Ambient Light Compensation (ALC) can only be enabled on your display when the display function is set to DICOM. Please refer to “[Display function](#)”, page 31.

When ALC is enabled, the DICOM display function will be recalculated taking a preset ambient light correction value into account. This value is determined by the selected reading room. Therefore, it is also important to select a realistic reading room when enabling ALC. This can be done by following the instructions in “[Reading room](#)”, page 32.

To enable/disable ALC

1. Bring up the OSD main menu.

2. Navigate to the *Embedded QA/Calibration Status* menu.
3. Enter the *Ambient Light Compensation* submenu.
4. Select *Enabled/Disabled* as desired and confirm.

4.14 Reading room

About reading room



Reading rooms can only be selected on your display when the display function is set to DICOM. Please refer to [“Display function”, page 31](#)

The American Association of Physicists in Medicine (AAPM) composed a list of pre-defined reading rooms. Each of these reading rooms are defined by following parameters:

- the maximum light allowed in this type of room
- the preset ambient light correction value for this reading room

These parameters are stored in your display and determine the preset ambient light correction value to take into account to recalculate the DICOM display function when Ambient Light Compensation (ALC) is enabled. Please refer to [“Ambient Light Compensation \(ALC\)”, page 31](#) to enable ALC.

The available reading rooms for your Nio 2MP / 3MP LED Display are:

- **CR/DR/ MAMMO:** Corresponds to light conditions in diagnostic reading rooms for computed radiology, digital radiology or mammography. This setting has the lowest maximum ambient light.
- **CT/MR/NM:** Corresponds to light conditions in diagnostic reading rooms for computed tomography, magnetic resonance or nuclear medicine scans.
- **Staff Office:** Corresponds to light conditions in office rooms.
- **Clinical Viewing Room:** Corresponds to light conditions in diagnostic reading rooms for clinical viewing.
- **Emergency Room:** Corresponds to light conditions in emergency rooms.
- **Operating Room:** Corresponds to light conditions in operating rooms. This setting has the highest maximum ambient light.

To select a reading room

1. Bring up the OSD main menu.
2. Navigate to the *Embedded QA* menu.
3. Enter the *Reading Room* submenu.
4. Select a desired reading room and confirm.

4.15 Embedded QA

About Embedded QA

Embedded QA allows you to run a display calibration or compliance test directly from the display using the OSD menus described in the next sections. Embedded QA will use the front sensor / I-Guard to measure the necessary luminance levels for either a calibration or compliance test. Various settings for both actions can be selected from the display's OSD menu. The last results of both actions can be consulted from the OSD.

Embedded QA or QAWeb Enterprise?

Embedded QA is not a replacement for the Barco QAWeb Enterprise solution.

Although Embedded QA is a reliable option to perform a simple calibration or compliance test, Barco still highly recommends QAWeb Enterprise as the solution of choice for calibration and QA. QAWeb Enterprise brings many benefits such as centralized asset management, the ability to schedule tasks, remote management, automated reporting, alerting and specific support of regional QA standards such as DIN 6868-57, JESRA and AAPM TG18. That's why QAWeb Enterprise Agent acts as the master for all supported

displays from the moment it is installed and running. QAWeb Enterprise Agent will take over from Embedded QA and overwrite any settings which were applied by Embedded QA.

4.15.1 DICOM status report

About DICOM status report

- **DICOM Compliance status:** Shows if the current DICOM curve is compliant or not.
- **Maximum error:** Shows the maximum error of the current DICOM curve. This is the deviation compared to a perfect DICOM.
- **Luminance:** Shows the measured luminance.
- **Black luminance:** Shows the measured black luminance.
- **Time elapsed since latest compliance check:** Shows the backlight runtime since last compliance check.
- **DICOM Calibration Status**
 - **Not executed:** No other information is visible.
 - **Calibration executed:** When the calibration is executed, the time elapsed since latest calibration is shown.
- **Time elapsed since latest calibration:** Shows the backlight runtime since last calibration check.
- **DICOM compliance check:** Measures the DICOM curve of your display in different steps.
- **DICOM calibration:** Adds a correction to the current DICOM curve to approach the perfect DICOM curve as well as possible.
- **DICOM Error threshold:** Sets the error threshold. This is the maximum error allowed before a DICOM calibration is required.
- **Ambient Light Compensation:** Disables/Enables the ambient light compensation function.
- **Reading Room:** Selects a reading room.
- **Reset DICOM Calibration:** Restores the original (factory default) DICOM curve.

To retrieve the DICOM status report

1. Bring up the OSD main menu.
2. Navigate to the *Embedded QA* menu to make the information visible on the screen.

4.15.2 DICOM compliance check

About DICOM compliance check

The DICOM compliance check will measure the DICOM curve of your display in different steps. After measurement, the DICOM status report is shown.

To start DICOM compliance check

1. Bring up the OSD main menu.
2. Navigate to the *Embedded QA* menu.
3. Select *DICOM Compliance Check* to start the compliance check.



Warning: Press and hold the jog dial for approximately 3 seconds during the compliance check will abort the check.

4.15.3 DICOM calibration

About DICOM calibration

The DICOM calibration will add a correction to the current DICOM curve to approach the perfect DICOM curve as well as possible.

To start DICOM calibration

1. Bring up the OSD main menu.
2. Navigate to the *Embedded QA* menu.

3. Select *DICOM Calibration* to start the calibration.



Warning: Press and hold the jog dial for approximately 3 seconds during calibration will abort the calibration, previous values will be restored.



Note: After calibration, the compliance check will start automatically.

4.15.4 DICOM error threshold

About DICOM error threshold

The threshold to define the DICOM compliance can be modified in steps of 5% starting from 5 to 30%. When the maximum deviation is not bigger than the selected threshold, the compliance check will be OK.

To set the DICOM error threshold:

1. Bring up the OSD menu.
2. Navigate to the *Embedded QA* menu.
3. Enter the *DICOM Error Threshold* submenu.
4. Set *DICOM error threshold* as desired and confirm.

4.15.5 Reset DICOM calibration

About reset DICOM calibration

It is possible to restore the original (factory default) DICOM curve.

To reset the DICOM calibration:

1. Bring up the OSD main menu.
2. Navigate to the *Embedded QA* menu.
3. Enter the *Reset DICOM Calibration* submenu.
4. Select *Confirm* to restore the original (not corrected) DICOM curve.

4.16 Image source

About the image source

By default, your Nio 2MP / 3MP LED Display automatically detects the connected image sources. You can also manually select the image sources via the OSD menu.



The *Image Source* menu is not available when the *KVM switch* is enabled. (to disable, see "[KVM switch](#)", page 35)

To automatically select image sources

1. Bring up the OSD main menu.
2. Navigate to the *Image Settings* menu.
3. Enter the *Image source* submenu
4. Select *Auto* and confirm.

To manually select image sources

1. Bring up the OSD main menu.
2. Navigate to the *Image Settings* menu.
3. Enter the *Image source* submenu
4. Select *DisplayPort 1* or *DisplayPort 2* as desired and confirm.

4.17 KVM switch

About KVM switch

The Nio 2MP / 3MP LED Display can be used in dual workstation setup with KVM switch. This allows the display to be connected to two different workstations and control both with a single keyboard and mouse connected to the display. Switching the video and control signals between the two workstations is done with the KVM switch, which must be enabled as explained below.



Your display system must be specifically set up and configured for KVM input switching. For instructions, see [“Dual workstation setup with KVM switch”, page 14](#).

To enable/disable the KVM switch

1. Bring up the OSD main menu.
2. Navigate to the *Image Settings* menu.
3. Enter the *KVM Switch* submenu.
4. Select *Enabled/Disabled* as desired and confirm.



When enabling the KVM switch, the *Image Source* menu will be inaccessible.

To switch KVM inputs

1. Bring up the OSD main menu.
2. Navigate to the *Image Settings* menu.
3. Enter the *KVM Input Selection* submenu.
4. Select *input 1* or *input 2* as desired and confirm.



When switching KVM inputs, the video is switched instantly while switching the USB signal might take a little longer (up to 2 seconds).



KVM input switching can also be done more quickly via the shortcut bar. See [“KVM input switching”, page 23](#).

4.18 Grayscale conversion modes



Your Nio 2MP / 3MP LED Display automatically detects the connected video input signals and applies the correct grayscale conversion settings. Manually selecting a grayscale conversion mode is possible, but then your display's image source selection mode should be set to allow this. Refer to [“Image source”, page 34](#) or [“KVM switch”, page 35](#) to do this.

About grayscale conversion modes

Grayscale conversion modes specify how color generated on the display controller is converted to grayscale in your display.

The available grayscale conversion modes are:

- **No conversion**
- **Use All Channels:** This mode is intended for grayscale displays where gray is sent over all channels.

To manually select a grayscale conversion mode:

1. Bring up the OSD main menu.

2. Navigate to the *Image Settings* menu.
3. Enter the *Grayscale Conversion* submenu.
4. Select a desired color conversion mode and confirm.

4.19 System info

About system info

Your display serial number, native resolution, firmware version, etc. are available in a dedicated submenu of the OSD menu.

To retrieve info. about your display

1. Bring up the OSD main menu.
2. Navigate to the *System Info* menu to make the information visible on the screen.

4.20 Calibration status

About calibration status

The calibration status menu not only provides the current calibration status of the display (display function, luminance, ALC, etc.) but also provides a shortcut to *Display Function*, *Luminance Target*, *Color Temperature/White Tint*, *Reading Room* and *Ambient Light Compensation* submenus.

To retrieve/set the calibration status of your display

1. Bring up the OSD main menu.
2. Navigate to the *Calibration Status* menu to display the calibration status.
3. Enter an accessible submenu.
4. Set the calibration status as desired and confirm.

4.21 Maximum luminance demo

About maximum luminance demo

The maximum luminance demo sets the luminance of the LCD panel to its maximum value for 60 seconds, or until the demo is manually cancelled. The actual measured luminance is shown on-screen.



While activated, the maximum luminance demo disables the display's backlight stabilizer and sets the *Color Temperature/White Tint* to *Native White*. When the maximum luminance demo is cancelled, the original settings are restored.

To activate the maximum luminance demo

1. Bring up the OSD main menu.
2. Navigate to *Service Mode* submenu.
3. Enter the keycode: 5-0-4-0 to bring up the service mode menu.
4. Navigate to the *Maximum Luminance Demonstration* submenu.
5. Select *Enabled* to activate the maximum luminance demonstration.
6. Select *Disabled* to manually cancel the maximum luminance demonstration, or wait for 60 seconds after which the demonstration is automatically cancelled.

Cleaning the display

5

5.1 Cleaning instructions

To clean the display

Apply a cleaning/disinfecting product to a soft lint-free cloth, such as a microfiber or gauze and rub the display surface thoroughly. In order to be effective, all surfaces must be cleaned for a certain amount of time (ranging from 30 seconds to 2 minutes).

Use a cleaning/disinfecting product that is alcohol-, alkali-, water- or chlorine-based. Common examples are:

- Isopropanol 100%
- Ethanol 70%
- 0.5% Chlorhexidine in 70% ethanol/isopropanol
- Ortho-Phthalaldehyde (OPA) 0.55%
- Haemo-sol, 1% in water
- 250 ppm Chlorine solution
- 1.0% Iodine in 70% ethanol
- 1.6% aqueous ammonia
- "Green soap" (USP)
- 0.5% Chlorhexidine in 70% isopropyl alcohol
- Products similar to optical cleaning liquid
- Bacillol AF
- Flux
- Sodium hypochlorite 10%

When selecting an alternative cleaning/disinfecting product, it is recommended to always identify the active ingredients. In case of doubt about a certain cleaning product, use plain water.

Do not use any of the following products:

- Alcohol in concentrations > 70%
- Strong alkalis lye, strong solvents
- Acetone
- Toluene
- Acids
- Detergents containing fluoride
- Detergents containing ammonia
- Detergents containing abrasives
- Steel wool
- Sponge with abrasives
- Steel blades
- Cloths with steel thread
- Paper-based cloths (e.g. paper towels, facial tissues, toilet paper)



CAUTION: Read and follow all instructions on the label of the cleaning product.



CAUTION: Take care not to damage or scratch the front glass or LCD. Be careful with rings or other jewelry and do not apply excessive pressure on the front glass or LCD.



CAUTION: When a small object or dust is tucked between the front bezel and the LCD surface (for displays without front glass), carefully remove with a soft object such as a plastic card or finger nail. Do not use sharp objects such as paperclips or tweezers to avoid damage to the LCD.



CAUTION: Do not apply or spray liquid directly to the display as excess liquid may cause damage to internal electronics. Instead, apply the liquid to a cleaning cloth.

Repackaging instructions

6

6.1 Repackaging instructions

Overview of the packaging

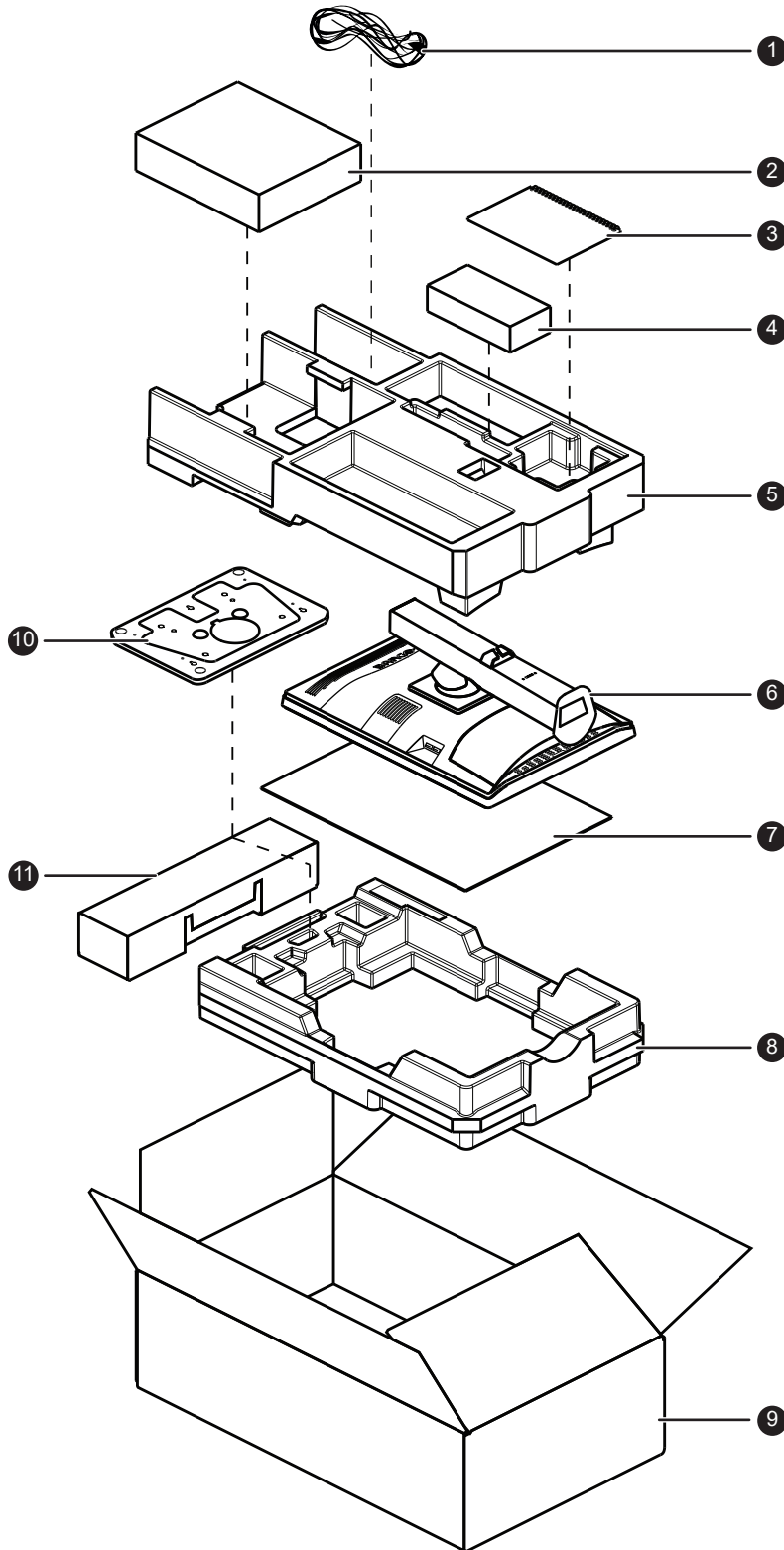

Image 6-1

1. Cables for mains, video and USB
2. Display controller box

3. System CD('s) and user guide
4. External power supply
5. Top buffer
6. Display
7. Cardboard⁴
8. Bottom buffer
9. Box
10. Stand base plate
11. Buffer box

To repack your display

1. Place the empty box on a stable surface.
2. Place the bottom buffer in the box.
3. Position the buffer box next to the bottom buffer.
4. Place the cardboard⁴ on the bottom buffer.
5. Put the display in the lowest position and lock the stand locking mechanism.

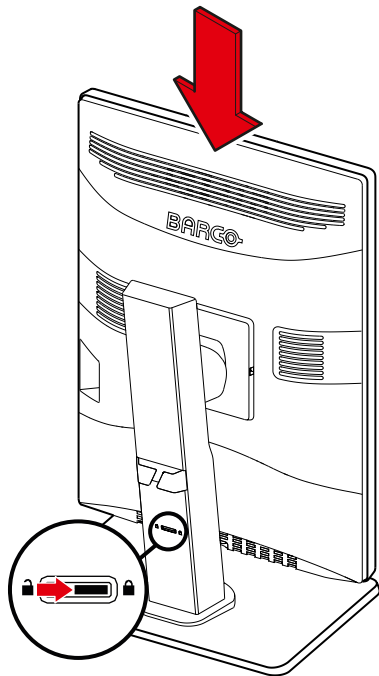

Image 6-2

6. Put the display in its original bag and place it in the box with the panel facing downwards as shown below:

⁴ MDNC-2521 SNES and MDNC-3521 SNES version only.

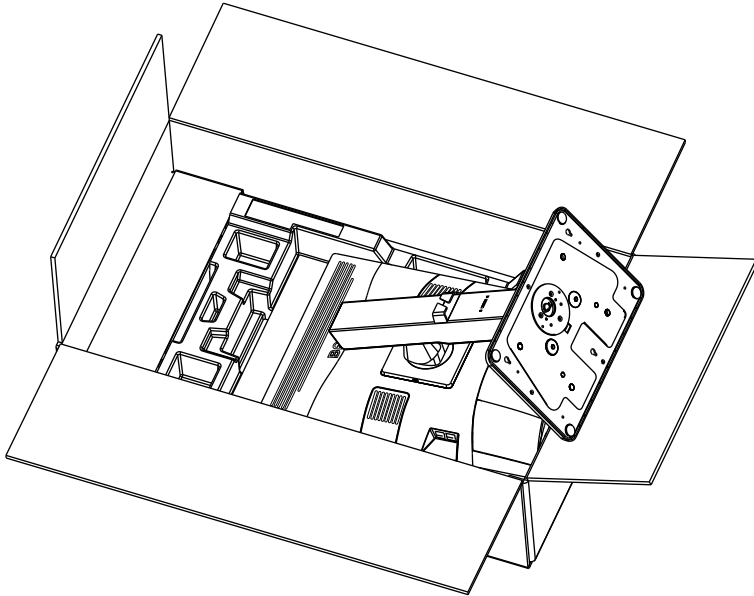

Image 6-3

7. Remove the stand base plate from the pillar by unscrewing the dedicated nut as shown below:

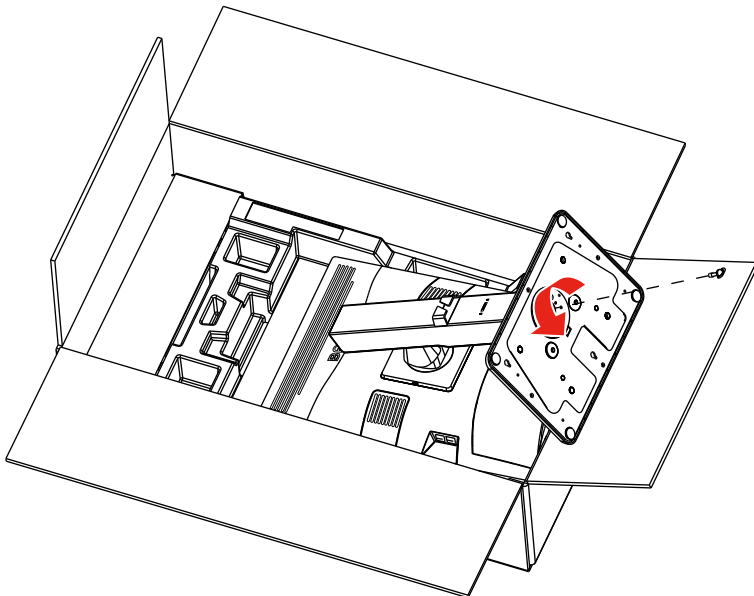

Image 6-4

8. Adjust the position of the display so that it fits perfectly with the box.

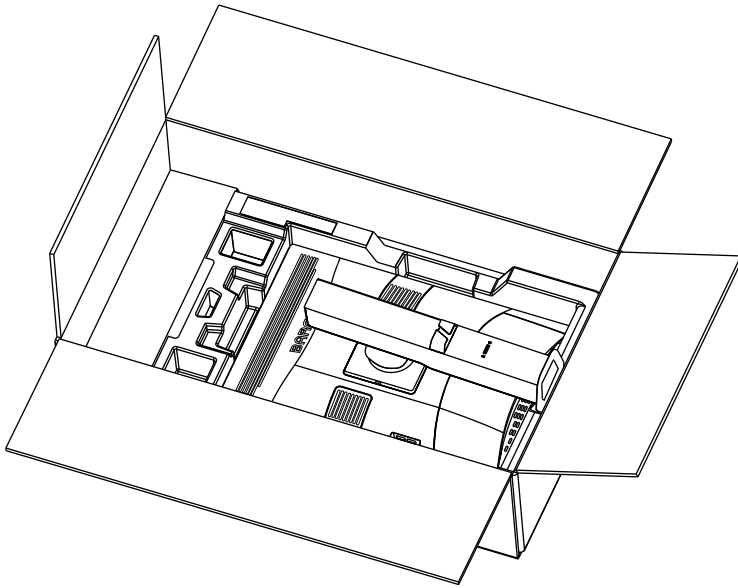

Image 6-5

9. Place the removed stand base plate on the buffer box.
10. Place the top buffer on top of the display and stand base plate.
11. Place the accessories and all cables in the dedicated cavities of the top buffer.
12. Close and seal the box.

Important information

7

7.1	Safety information.....	46
7.2	Cybersecurity.....	48
7.3	Environmental information.....	49
7.4	Regulatory compliance information.....	50
7.5	EMC notice.....	52
7.6	Explanation of symbols.....	54
7.7	Legal disclaimer.....	58
7.8	Open source license information.....	58
7.9	Technical specifications.....	59

7.1 Safety information

General recommendations

- Read the safety and operating instructions before operating the device.
- Retain safety and operating instructions for future reference.
- Adhere to all warnings on the device and in the operating instructions manual.
- Follow all instructions for operation and use.

Electrical Shock or Fire Hazard

- To prevent electric shock or fire hazard, do not remove cover.
- No serviceable parts inside. Refer servicing to qualified personnel.
- Do not expose this apparatus to rain or moisture.

Modifications to the unit

- Do not modify this equipment without authorization of the manufacturer.

Type of protection (Electrical)

- Equipment with external power supply: Class I equipment

Degree of safety (flammable anesthetic mixture)

- Equipment not suitable for use in the presence of a flammable anesthetic mixture with air or with oxygen or nitrous oxide.



Non-patient care equipment

- Equipment primarily for use in a health care facility that is intended for use where contact with a patient is unlikely (no applied part).
- The equipment shall not be used with life support equipment.
- The user should not touch the equipment, nor its signal input ports (SIP)/signal output ports (SOP) and the patient at the same time.

Child safety

- Equipment not suitable for use in locations where children are likely to be present.

Power connection – Equipment with external 24 VDC power supply

- Power requirements: The equipment must be powered using the delivered medical approved 24 VDC () SELV power supply.
- The medical approved DC () power supply must be powered by the AC mains voltage.
- The power supply is specified as a part of the ME equipment or combination is specified as a ME system.
- To avoid the risk of electric shock, this equipment must only be connected to a supply mains with protective earth.
- The equipment should be installed near an easily accessible outlet.
- The equipment is intended for continuous operation.

Transient over-voltage

- If the device is not used for a long time, disconnect it from the AC inlet to avoid damage by transient over-voltage.

To fully disengage the power to the device, please disconnect the power cord from the AC inlet.

High magnetic environment

- The device shall not be used in the high magnetic environment of an MRI scanner.

- The installer shall assess the magnetic environment before installation or use of the device.

Power cords

- Do not overload wall outlets and extension cords as this may result in fire or electric shock.
- Mains lead protection (U.S.: Power cord): Power cords should be routed so that they are not likely to be walked upon or pinched by items placed upon or against them, paying particular attention to cords at plugs and receptacles.
- Use a power cord that matches the voltage of the power outlet, which has been approved and complies with the safety standard of your particular country.
- Korea: Use KC certified products; Plug: 250 V~, 16 A; Power cord: 60227 IEC 53, 3G0.75 mm² / 60227 IEC 53, 3G1.0 mm²; Connector: 250 V~, 10 A

Accessory equipment

Accessory equipment connected to the analog and digital interfaces must be in compliance with the respective nationally harmonized IEC standards (i. e. IEC 60950 for data processing equipment, IEC 60065 for video equipment, IEC 61010-1 for laboratory equipment, and IEC 60601-1 for medical equipment.) Furthermore all configurations shall comply with the system standard IEC 60601-1-1. Anyone who connects additional equipment to the signal input part or signal output part is configuring a medical system, and is therefore, responsible that the system complies with the requirements of the system standard IEC 60601-1-1. If in doubt, consult the technical services department or your local representative.

Water and moisture

Never expose the device to rain or moisture.

Never use the device near water - e.g. near a bathtub, washbasin, swimming pool, kitchen sink, laundry tub or in a wet basement.

Ventilation

Do not cover or block any ventilation openings in the cover of the set. When installing the device in a cupboard or another enclosed location, heed the necessary space between the set and the sides of the cupboard.

Installation

Place the device on a flat, solid and stable surface that can support the weight of at least 3 devices. If you use an unstable cart or stand, the device may fall, causing serious injury to a child or adult, and serious damage to the device.

Malfunctions

Disconnect the equipment's power cord from the AC inlet and refer servicing to qualified service technicians under the following conditions:

- If the power cord or plug is damaged or frayed.
- If liquid has been spilled into the equipment.
- If the equipment has been exposed to rain or water.
- If the equipment does not operate normally when the operating instructions are followed. Adjust only those controls that are covered by the operating instructions since improper adjustment of other controls may result in damage and will often require extensive work by a qualified technician to restore the product to normal operation.
- If the equipment has been dropped or the cabinet has been damaged.
- If the product exhibits a distinct change in performance, indicating a need for service.

National Scandinavian Deviations for CL. 1.7.2

Finland: "Laitte on liitettävä suojamaadoituskoskettimilla varustettuun pistorasiaan"

Norway: "Apparatet må tilkoples jordet stikkontakt"

Sweden: "Apparaten skall anslutas till jordat uttag"

7.2 Cybersecurity

Security objectives

The Nio 2MP / 3MP LED Display will be used for displaying and viewing digital images. Therefore, ensuring the availability of the digital images has been identified as the primary security objective of this product.

Nevertheless, the availability, integrity, and confidentiality of information processed by the product relies on the non-mandatory security recommendations described below.

The lack of storage or processing of patient or personal information, combined with the limited (network) connectivity, results in the Nio 2MP / 3MP LED Display entailing a low cybersecurity risk profile.

Security recommendations

The security measures listed below should be considered as a non-exhaustive list of possible security controls for the operating environment. The operating environment must not hinder the application of security measures on the product or force the device to operate in a lower security setting.

The operator shall maintain the necessary state-of-the-art policies, processes, standards and other security controls to incorporate, support and protect the product. This shall include the application of risk management (e.g. by implementing relevant standards).

The operating environment should provide physical security via security measures such as:

- Regulated and authenticated physical access enforced via suitable technical measures (e.g. badges)
- Physical security policy defining roles and access rights, including for physical access to the product
- Use of segregated, secure areas with appropriate access controls

The operating environment should include appropriate security controls such as:

- User access management (credentials for accessing software applications or devices, user access policy, etc.)
- Antivirus / anti-malware software
- Firewall
- Application whitelisting / system hardening
- Exclusive use of genuine software and ban of all illegitimate software and applications
- Session management measures (e.g. session timeouts)

The operating environment should provide control and security of network traffic via appropriate measures, such as:

- Network segmentation & network access control
- Traffic filtering
- Encrypted communication

Specifically for workstations connected to the product, appropriate security measures include:

- Operating system hardening and application whitelisting
- Use of strong passwords
- Install only software necessary for the intended use of the operating environment.

To ensure that the security posture of the operating environment and of the product itself remain at a suitable level, appropriate provisions regarding patch management should be in place, such as:

- The operating environment should support patching without compromising interoperability/compatibility
- The operator should have appropriate patch management processes to ensure that security patches for the product are deployed in a timely manner
- The operator should have appropriate patch management processes to ensure that the operating environment (e.g. operating systems, applications) is up-to-date in terms of security

7.3 Environmental information

Disposal Information



Waste Electrical and Electronic Equipment (WEEE)

This symbol on the product indicates that, under the European Directive 2012/19/EU governing waste from electrical and electronic equipment, this product must not be disposed of with other municipal waste. Please dispose of your waste equipment by handing it over to a designated collection point for the recycling of waste electrical and electronic equipment. To prevent possible harm to the environment or human health from uncontrolled waste disposal, please separate these items from other types of waste and recycle them responsibly to promote the sustainable reuse of material resources.

For more information about recycling of this product, please contact your local city office or your municipal waste disposal service. For details, please visit the Barco website at: <https://www.barco.com/about/sustainability/waste-of-electronic-equipment-customers>

Turkey RoHS compliance



Türkiye Cumhuriyeti: AEEE Yönetmeliğine Uygundur.

[Republic of Turkey: In conformity with the WEEE Regulation]

中国大陆 RoHS

Chinese Mainland RoHS

根据中国大陆《电器电子产品有害物质限制使用管理办法》（也称为中国大陆RoHS），以下部分列出了Barco产品中可能包含的有毒和/或有害物质的名称和含量。中国大陆RoHS指令包含在中国信息产业部MCV标准：“电子信息产品中有毒物质的限量要求”中。

According to the “Management Methods for the Restriction of the Use of Hazardous Substances in Electrical and Electronic Products ” (Also called RoHS of Chinese Mainland), the table below lists the names and contents of toxic and/or hazardous substances that Barco’s product may contain. The RoHS of Chinese Mainland is included in the MCV standard of the Ministry of Information Industry of China, in the section “Limit Requirements of toxic substances in Electronic Information Products”.

零件项目(名称) Component name	有毒有害物质或元素 Hazardous substances and elements					
	铅 Pb	汞 Hg	镉 Cd	六价铬 Cr6+	多溴联苯 PBB	多溴二苯醚 PBDE
印制电路配件 Printed Circuit Assemblies	X	O	O	O	O	O
液晶面板 LCD panel	X	O	O	O	O	O
外接电(线)缆 External Cables	X	O	O	O	O	O
内部线路 Internal wiring	O	O	O	O	O	O
金属外壳 Metal enclosure	O	O	O	O	O	O
塑胶外壳 Plastic enclosure	O	O	O	O	O	O
散热片(器) Heatsinks	O	O	O	O	O	O
风扇 Fan	O	O	O	O	O	O
电源供应器	X	O	O	O	O	O

零件项目(名称) Component name	有毒有害物质或元素 Hazardous substances and elements					
	铅 Pb	汞 Hg	镉 Cd	六价铬 Cr6+	多溴联苯 PBB	多溴二苯醚 PBDE
Power Supply Unit						
文件说明书 Paper Manuals	○	○	○	○	○	○
光盘说明书 CD manual	○	○	○	○	○	○
本表格依据SJ/T 11364的规定编制 This table is prepared in accordance with the provisions of SJ/T 11364. ○: 表示该有毒有害物质在该部件所有均质材料中的含量均在 GB/T 26572 标准规定的限量要求以下。 ○: Indicates that this toxic or hazardous substance contained in all of the homogeneous materials for this part is below the limit requirement in GB/T 26572. X: 表示该有毒有害物质至少在该部件的某一均质材料中的含量超出 GB/T 26572 标准规定的限量要求。 X: Indicates that this toxic or hazardous substance contained in at least one of the homogeneous materials used for this part is above the limit requirement in GB/T 26572.						

在中国大陆销售的相应电子信息产品（EIP）都必须遵照中国大陆《电子电气产品有害物质限制使用标识要求》标准贴上环保使用期限（EFUP）标签。Barco产品所采用的EFUP标签（请参阅实例，徽标内部的编号用于指定产品）基于中国大陆的《电子信息产品环保使用期限通则》标准。

All Electronic Information Products (EIP) that are sold within Chinese Mainland must comply with the “Marking for the restriction of the use of hazardous substances in electrical and electronic product” of Chinese Mainland, marked with the Environmental Friendly Use Period (EFUP) logo. The number inside the EFUP logo that Barco uses (please refer to the photo) is based on the “General guidelines of environment-friendly use period of electronic information products” of Chinese Mainland.



中国RoHS自我声明符合性标志 / China RoHS – SDoC mark

本产品符合《电器电子产品有害物质限制使用管理办法》和《电器电子产品有害物质限制使用达标管理目录》的要求。

This product meets the requirements of the “Management Rule on the Use Restriction of Hazardous Substances in Electrical and Electronic Products” and the “Management Catalogue for the Use Restriction of Hazardous Substances in Electrical and Electronic Products”.



绿色自我声明符合性标志可参见电子档文件

The green SDoC mark is visible in the digital version of this document.

7.4 Regulatory compliance information

Indications for use

The display is intended to be used for displaying and viewing digital images (excluding digital mammography) for review and analysis by trained medical practitioners.

Intended usage environment

- The display is not in contact nor in the same environment (within 1.5m) as a person actively undergoing a medical, surgical or dental procedure.

- The device is intended to be used in a healthcare facility or a medical professional's workplace.

Caution (USA): Federal law restricts this device to sale by or on the order of a physician. (Details & exemptions are in the Code of Federal Regulations Title 21, 801 Part D).

Contra-indications

- The device is not intended for digital mammography.
- The device is not intended to be used in conjunction with high powered medical equipment (HF surgical equipment, short-wave therapy equipment, equipment inside the RF shielded room for magnetic resonance imaging).

Intended users

Barco diagnostic displays are intended to be used for primary diagnosis by trained medical practitioners. The device is initially set up by professional integrators or medical staff.

Notice to the user and/or patient

Any serious incident that has occurred in relation to the device should be reported to the manufacturer and the competent authority of the Member State in which the user and/or patient is established.

Factory addresses

- **Barco NV**, President Kennedypark 35, 8500 Kortrijk, Belgium
- **Fimi S.r.l.**, Via Saul Banfi 1, 21047 Saronno, VA, Italy
- **巴可 (苏州) 医疗科技有限公司**, 苏州工业园区苏桐路111号
Barco (Suzhou) Healthcare Technology Co., Ltd., No.111, Sutong Road, Suzhou Industrial Park, 215021 Suzhou China

Manufacturing country

The manufacturing country of the product is indicated on the product label ("**Made in ...**").

Importers contact information

To find your local importer, contact one of Barco's regional offices via the contact information provided on our website (www.barco.com).

FCC class B

This device complies with Part 15 of the FCC Rules. Operation is subject to the following two conditions: (1) this device may not cause harmful interference, and (2) this device must accept any interference received, including interference that may cause undesired operation.

This device has been tested and found to comply with the limits for a Class B digital device, pursuant to Part 15 of the FCC Rules. These limits are designed to provide reasonable protection against harmful interference in a residential installation. This device generates, uses and can radiate radio frequency energy and, if not installed and used in accordance with the instructions, may cause harmful interference to radio communications. However, there is no guarantee that interference will not occur in a particular installation. If this device does cause harmful interference to radio or television reception, which can be determined by turning the device off and on, the user is encouraged to try to correct the interference by one or more of the following measures:

- Reorient or relocate the receiving antenna.
- Increase the separation between the device and receiver.
- Connect the device into an outlet on a circuit different from that to which the receiver is connected.
- Consult the dealer or an experienced radio/TV technician for help.

Changes or modifications not expressly approved by the party responsible for compliance could void the user's authority to operate the equipment.

FCC responsible: Barco Inc., 3059 Premiere Parkway Suite 400, 30097 Duluth GA, United States, Tel: +1 678 475 8000

Canadian notice

CAN ICES-001(B) / NMB-001(B)

Brazilian local representative

Barco Ltda, Av. Ibirapuera, 2332 - Andar 8 - Bloco 2 - Conj 82, Bairro:Ibirapuera, Distrito:Moema, 4028-002, São Paulo, Brasil

7.5 EMC notice

General information

This device is for use in professional healthcare facility environments only.

With the installation of the device, use only the delivered external cables and power supply or a spare part provided by the legal manufacturer. Using another can result in a decrease of the immunity level of the device.



WARNING: Use of this equipment adjacent to or stacked with other equipment should be avoided because it could result in improper operation. If such use is necessary, this equipment and the other equipment should be observed to verify that they are operating normally.



WARNING: Use of accessories, transducers and cables other than those specified or provided by the manufacturer of this equipment could result in increased electromagnetic emissions or decreased electromagnetic immunity of this equipment and result in improper operation.



WARNING: Portable RF communications equipment (including peripherals such as antenna cables and external antennas) should be used no closer than 30 cm (12 inches) to any part of the Nio 2MP / 3MP LED Display, including cables specified by the manufacturer. Otherwise, degradation of the performance of this equipment could result.

Electromagnetic emissions

The Nio 2MP / 3MP LED Display is intended for use in the electromagnetic environment specified below. The customer or the user of the Nio 2MP / 3MP LED Display should assure that it is used in such an environment.

Emissions test	Compliance	Electromagnetic environment – Guidance
RF emissions CISPR 11	Group 1	The Nio 2MP / 3MP LED Display uses RF energy only for its internal function. Therefore, its RF emissions are very low and are not likely to cause any interference in nearby electronic equipment.
RF emissions CISPR 11	Class B	The Nio 2MP / 3MP LED Display is suitable for use in all establishments, including domestic establishments and those directly connected to the public low-voltage power supply network that supplies buildings used for domestic purposes.
Harmonic emissions IEC 61000-3-2	Class D	
Voltage fluctuations/ flicker emissions IEC 61000-3-3	Complies	

This Nio 2MP / 3MP LED Display complies with appropriate medical EMC standards on emissions to, and interference from surrounding equipment. Operation is subject to the following two conditions: (1) this device may not cause harmful interference, and (2) this device must accept any interference received, including interference that may cause undesired operation.

Interference can be determined by turning the equipment off and on.

If this equipment does cause harmful interference to, or suffer from harmful interference of, surrounding equipment, the user is encouraged to try to correct the interference by one or more of the following measures:

- Reorient or relocate the receiving antenna or equipment.
- Increase the separation between the equipment and receiver.
- Connect the equipment into an outlet on a circuit different from that to which the receiver is connected.
- Consult the dealer or an experienced technician for help.

Electromagnetic immunity

The Nio 2MP / 3MP LED Display is intended for use in the electromagnetic environment specified below. The customer or the user of the Nio 2MP / 3MP LED Display should assure that it is used in such an environment.

Immunity test	IEC 60601-1-2 test levels	Compliance level	Electromagnetic environment – guidance
Electrostatic discharge (ESD) IEC 61000-4-2	± 8 kV contact ± 2 kV, ± 4 kV, ± 8 kV, ± 15 kV air	± 8 kV contact ± 2 kV, ± 4 kV, ± 8 kV, ± 15 kV air	Floors should be wood, concrete or ceramic tile. If floors are covered with synthetic material, the relative humidity should be at least 30%
Electrical fast transient/burst IEC 61000-4-4	± 2 kV for power supply lines ± 1 kV for input/ output lines 100 kHz repetition frequency	± 2 kV for power supply lines ± 1 kV for input/ output lines 100 kHz repetition frequency	Mains power quality should be that of a typical commercial or hospital environment
Surge IEC61000-4-5	Line to line: ± 0.5 kV, ± 1 kV Line to ground: ± 0.5 kV, ± 1 kV, ± 2 kV	Line to line: ± 0.5 kV, ± 1 kV Line to ground: ± 0.5 kV, ± 1 kV, ± 2 kV	Mains power quality should be that of a typical commercial or hospital environment
Voltage dips, short interruptions and voltage variations on power supply input lines IEC 61000-4-11	0% residual voltage for 0.5 period at 0°, 45°, 90°, 135°, 180°, 225°, 270° and 315° 0% residual voltage for 1 period at 0° 70% residual voltage for 25 periods at 0° Voltage interruptions: 0% residual voltage for 250 periods at 0°	0% residual voltage for 0.5 period at 0°, 45°, 90°, 135°, 180°, 225°, 270° and 315° 0% residual voltage for 1 period at 0° 70% residual voltage for 25 periods at 0° Voltage interruptions: 0% residual voltage for 250 periods at 0°	Mains power quality should be that of a typical commercial or hospital environment. If the user of the Nio 2MP / 3MP LED Display requires continued operation during power mains interruptions, it is recommended that the Nio 2MP / 3MP LED Display be powered from an uninterruptible power supply or a battery
Power frequency (50/60 Hz) magnetic field IEC 61000-4-8	30 A/m	Not applicable ⁵	Power frequency magnetic fields should be at levels characteristic of a typical location in a typical commercial or hospital environment
Conducted RF IEC 61000-4-6	3 Vrms (6 Vrms in ISM bands) 150 kHz to 80 MHz	3 Vrms (6 Vrms in ISM bands)	-
Radiated RF IEC 61000-4-3	3 V/m 80 MHz to 2.7 GHz	3 V/m	

5. Nio 2MP / 3MP LED Display doesn't contain components that are susceptible to magnetic fields.



Immunity to RF wireless communications equipment















Test frequency (MHz)	Band (MHz)	Service	Modulation	Maximum power (W)	Distance (m)	Immunity test level (V/m)
385	380 – 390	TETRA 400	Pulse modulation 18 Hz	1.8	0.3	27
450	430 – 470	GMRS 460, FRS 460	FM \pm 5 kHz deviation 1 kHz sine	2	0.3	28
710	704 – 787	LTE Band 13, 17	Pulse modulation 217 Hz	0.2	0.3	9
745						
780						
810	800 – 960	GSM 800/ 900, TETRA 800, iDEN 820, CDMA 850, LTE Band 5	Pulse modulation 18 Hz	2	0.3	28
870						
930						
1720	1700 – 1990	GSM 1800, CDMA 1900, GSM 1900, DECT, LTE Band 1/3/4/ 25, UMTS	Pulse modulation 217 Hz	2	0.3	28
1845						
1970						
2450	2400 – 2570	Bluetooth, WLAN, 802.11 b/g/n, RFID 2450, LTE Band 7	Pulse modulation 217 Hz	2	0.3	28
5240	5100 – 5800	WLAN 802.11 a/n	Pulse modulation 217 Hz	0.2	0.3	9
5500						
5785						

















7.6 Explanation of symbols

Symbols on the device



On the device or power supply, you may find the following symbols (nonrestrictive list):

	Indicates the device meets the requirements of the applicable EC directives/regulations.
	Indicates compliance with Part 15 of the FCC rules (Class A or Class B).

	<p>Indicates the device is approved according to the UL regulations for Canada and US.</p>
	<p>Indicates the device is approved according to the UL Demko regulations.</p>
	<p>Indicates the device is approved according to the CCC regulations.</p>
	<p>Indicates the device is approved according to the VCCI regulations.</p>
	<p>Indicates the device is approved according to the KC regulations.</p>
	<p>Indicates the device is approved according to the BSMI regulations.</p>
	<p>Indicates the device is approved according to the PSE regulations.</p>
	<p>Indicates the device is approved according to the RCM regulations.</p>
	<p>Indicates the device is approved according to the EAC regulations.</p>
	<p>Caution: Federal law (United States of America) restricts this device to sale by or on the order of a licensed healthcare practitioner.</p>
<p>IS 13252 (Part 1) IEC 60950-1</p>  <p>R-xxxxxxx www.bis.gov.in</p>	<p>Indicates the device is approved according to the BIS regulations.</p>
	<p>Indicates the device is approved according to the INMETRO regulations.</p>
	<p>Indicates the USB connectors on the device.</p>
	<p>Indicates the DisplayPort connectors on the device.</p>





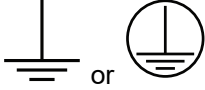

	Indicates the legal manufacturer.
	Indicates the manufacturing date.
	Indicates the entity importing the medical device into the locale.
	Indicates the temperature limitations ⁶ for the device to safely operate within specs.
	Indicates that the device is a Medical Device.
	Indicates the device Serial Number.
	Indicates the device part number or catalogue number.
	Indicates the Unique Device Identifier.
	Indicates the Authorised Representative for the European Union.
	Indicates the Authorised Representative for Switzerland.
	Warning: dangerous voltage
	Caution
	Consult the Instructions For Use.
	Consult the Instruction For Use on the website address that is provided as eIFU indicator.
	Indicates this device must not be thrown in the trash but must be recycled, according to the European WEEE (Waste Electrical and Electronic Equipment) directive.
	Indicates Direct Current (DC).

6. Values for xx and yy can be found in the technical specifications paragraph.

	Indicates Alternating Current (AC).
	Stand-by
	Equipotentiality
	Protective earth (ground)

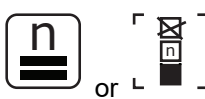
Symbols on the box

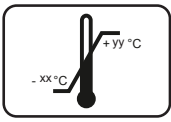
On the box of the device, you may find the following symbols (nonrestrictive list):

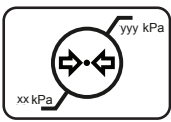
	Indicates a device that can be broken or damaged if not handled carefully when being stored.
	Indicates a device that needs to be protected from moisture when being stored.
	Indicates the storage direction of the box. The box must be transported, handled and stored in such a way that the arrows always point upwards.
	Indicates the maximum number of identical boxes which may be stacked on each other, where “n” is the limiting number.
	Indicates the weight of the box and that it should be carried with two persons.
	Indicates that the box should not be cut with a knife, a cutter or any other sharp object.
	Indicates the temperature limits ⁷ to which the device can be safely exposed when being stored.
	Indicates the range ⁷ of humidity to which the device can be safely exposed when being stored.
	Indicates the range ⁷ of atmospheric pressure to which the device can be safely exposed when being stored.

7. Values for xx and yy can be found in the technical specifications paragraph.

7.7 Legal disclaimer

Disclaimer notice

Although every attempt has been made to achieve technical accuracy in this document, we assume no responsibility for errors that may be found. Our goal is to provide you with the most accurate and usable documentation possible; if you discover errors, please let us know.

Barco software products are the property of Barco. They are distributed under copyright by Barco NV or Barco Inc., for use only under the specific terms of a software license agreement between Barco NV or Barco Inc. and the licensee. No other use, duplication, or disclosure of a Barco software product, in any form, is authorized.

The specifications of Barco products are subject to change without notice.

Trademarks

All trademarks and registered trademarks are property of their respective owners.

Copyright notice

This document is copyrighted. All rights are reserved. Neither this document, nor any part of it, may be reproduced or copied in any form or by any means - graphical, electronic, or mechanical including photocopying, taping or information storage and retrieval systems - without written permission of Barco.

© 2023 Barco NV all rights reserved.

Patent protection

Please refer to www.barco.com/about-barco/legal/patents.

Product Security Incident Response

As a global technology leader, Barco is committed to deliver secure solutions and services to our customers, while protecting Barco's intellectual property.

When product security concerns are received, the product security incident response process will be triggered immediately. To address specific security concerns or to report security issues with Barco products, please inform us via contact details mentioned on <https://www.barco.com/psirt>.

To protect our customers, Barco does not publicly disclose or confirm security vulnerabilities until Barco has conducted an analysis of the product and issued fixes and/or mitigations.

7.8 Open source license information

Open source license information

This product contains software components released under an Open Source license. You acknowledge living up to the conditions of each separate Open Source Software license.

A list of the Open Source Software components used is available in the applicable EULA, through the "My Barco" section of the Barco website or through other (online) means.

Copyright on each Open Source Software component belongs to the respective initial copyright holder, each additional contributor and/or their respective assignee(s), as may be identified in the respective Open Source Software documentation, source code, README file, or otherwise. You shall not remove or obscure or otherwise alter the respective copyrights.

EACH SEPARATE OPEN SOURCE SOFTWARE COMPONENT AND ANY RELATED DOCUMENTATION ARE PROVIDED "AS IS" WITHOUT EXPRESS OR IMPLIED WARRANTY INCLUDING, BUT NOT LIMITED TO, THE IMPLIED WARRANTIES OF MERCHANTABILITY AND FITNESS FOR A PARTICULAR PURPOSE. IN NO EVENT SHALL THE COPYRIGHTHOLDER OR ANY OTHER CONTRIBUTOR BE LIABLE FOR DIRECT, INCIDENTAL, SPECIAL, EXEMPLARY OR CONSEQUENTIAL DAMAGES, EVEN IF ADVISED OF THE POSSIBILITY OF SUCH DAMAGES, HOWEVER CAUSED AND ON ANY THEORY OF LIABILITY. MORE INFORMATION/DETAILS IS TO BE FOUND IN EACH SPECIFIC OPEN SOURCE LICENSE.

With respect to GPL, LGPL or similar licenses with regard to corresponding source code access and automatic license terms applicability:

- You acknowledge living up to the conditions of each such specific applicable Open Source Software license. You are responsible for your own additions, changes or modifications without any recourse or claim towards Barco whatsoever. You further acknowledge that any such additions, changes or modifications may impair the ability of Barco – at Barco’s sole discretion - to continue to provide service, warranties, software updates, fixes, maintenance, access or such similar abilities, without any recourse or claim towards Barco whatsoever.
- Barco offers to provide the corresponding source code, and shall make the corresponding source code available to you via email or download link, except where the applicable license entitles you to require Barco to provide you the corresponding source code on a tangible medium, in which case Barco will charge you for the actual costs of performing such distribution, such as the cost of media, shipping and handling. You may exercise this option upon written request to Barco N.V, attn. legal department, Beneluxpark 21, 8500 Kortrijk (Belgium). This offer is valid for a period of three (3) years from the date of the distribution of this product by Barco.

7.9 Technical specifications

MDNC-2521

Screen technology	IPS-SFT Color LCD
Active screen size (diagonal)	541 mm (21.3")
Active screen size (H x V)	433 x 325 mm (17.1 x 12.8")
Aspect ratio (H:V)	4:3
Resolution	2MP (1600 x 1200 pixels)
Pixel pitch	0.2707 mm
Color imaging	Yes
Gray imaging	Yes
Bit depth	30 bit
Viewing angle (H, V)	178°
Uniformity correction	ULT
SteadyColor Calibration	Yes (in MXRT display controller), when used as a system with MXRT display controller & QAWeb Enterprise
Ambient light presets	Yes, reading room selection
Ambient light sensor	Yes
Front sensor	Yes, I-Guard
Presence sensor	Yes
Maximum luminance (panel typical)	1000 cd/m ²
DICOM calibrated luminance	600 cd/m ²
Contrast ratio	2000:1
Response time ((Tr + Tf)/2) (typical)	12 ms (gray-to-gray average)
Housing color	Black (RAL 9004) / White (RAL 9003)

Video input signals	2x DisplayPort 1.4
USB ports	2x USB-B 2.0 upstream (endpoint) 5x USB-A 2.0 downstream (of which 1 charge port)
Power rating	24 VDC, 4 A
Power requirements	This device shall only be powered by the medical approved power supply of Adapter Technology Co., Ltd., type ATM160T-P240. Ratings marked on the power supply: <ul style="list-style-type: none"> • Input: 100-240 VAC, 1.8-0.9 A, 50-60 Hz • Output: 24 VDC, 6.6 A
Power consumption	37 W (nominal) < 0.35 W (hibernate) < 0.30 W (switched off)
Dimensions with stand (W x H x D)	Portrait: 351 x 531~631 x 225 mm Landscape: 491 x 462~562 x 225 mm
Dimensions w/o stand (W x H x D)	Portrait: 351 x 491 x 64 mm Landscape: 491 x 351 x 64 mm
Dimensions packaged (W x H x D)	455 x 210 x 770 mm
Net weight with stand	MDNC-2521 SPES: 8.8 kg MDNC-2521 SNES: 7.7 kg
Net weight w/o stand	MDNC-2521 SPES: 5.8 kg MDNC-2521 SNES: 4.7 kg
Net weight packaged	MDNC-2521 SPES: 12.2 kg (without optional accessories) MDNC-2521 SNES: 11.2 kg (without optional accessories)
Tilt	-10° to +30°
Swivel	-30° to +30°
Pivot	90°
Height adjustment range	100 mm
Mounting standard	VESA (100 mm)
Screen protection	MDNC-2521 SPES: Protective, anti-reflective front glass MDNC-2521 SNES: N/A
Recommended modalities	All digital images, except digital mammography
Certifications*	CE0123 (Medical Device) FDA 510(k) K230520 CCC (China), KC (Korea), BSMI (Taiwan), INMETRO (Brazil - Product numbers K9300380A, K9300381A) BIS (India), EAC (Russia, Kazakhstan, Belarus, Armenia and Kyrgyzstan) Safety specific: <ul style="list-style-type: none"> • IEC 60950-1:2005 + A1:2009 • EN 60950-1:2006 + A1:2010 + A11:2009 + A12:2011 + A2:2013 • IEC 62368-1:2018 • EN IEC 62368-1:2020 • IEC 60601-1:2005 + A1:2012 • EN 60601-1:2006 + A1:2013 + A12:2014

	<ul style="list-style-type: none"> • ANSI/AAMI ES 60601-1:2005 + R1:2012 • CAN/CSA C22.2 No. 60601-1:2014 <p>EMI specific:</p> <ul style="list-style-type: none"> • IEC 60601-1-2:2014 (ed4) • EN 60601-1-2:2015 (ed4) • FCC part 15 Class B • ICES-001 Level B • VCCI (Japan) <p>Environmental: China Energy Label, EU RoHS, China RoHS, REACH, Canada Health, WEEE, Packaging Directive</p> <p>*Some of the listed certifications may still be pending. For the actual list of applicable certifications, please refer to the product page on www.barco.com or see the certification marks on the product label of your display.</p>
Supplied accessories	<ul style="list-style-type: none"> • User Guide • Documentation disc • System sheet • Video cables • Mains cable(s) • USB cable • External power supply
Optional accessories	Display controller
QA software	QAWeb Enterprise
Warranty	5 years, including 20000 hours backlight warranty
Operating temperature	0 °C to 35 °C (20 °C to 30 °C within specs)
Storage temperature	-20 °C to 60 °C
Operating humidity	8 % to 80 % (non-condensing)
Storage humidity	5 % to 85 % (non-condensing)
Operating pressure	70 kPa minimum
Storage pressure	50 to 106 kPa

MDNC-3521

Screen technology	IPS-SFT Color LCD
Active screen size (diagonal)	541 mm (21.3")
Active screen size (H x V)	433 x 325 mm (17.1 x 12.8")
Aspect ratio (H:V)	4:3
Resolution	3MP (2048 x 1536 pixels)
Pixel pitch	0.2115 mm
Color imaging	Yes
Gray imaging	Yes
Bit depth	30 bit
Viewing angle (H, V)	178°

Uniformity correction	ULT
SteadyColor Calibration	Yes (in MXRT display controller), when used as a system with MXRT display controller & QAWeb Enterprise
Ambient light presets	Yes, reading room selection
Ambient light sensor	Yes
Front sensor	Yes, I-Guard
Presence sensor	Yes
Maximum luminance (panel typical)	1050 cd/m ²
DICOM calibrated luminance	600 cd/m ²
Contrast ratio	2000:1
Response time ((Tr + Tf)/2) (typical)	12 ms (gray-to-gray average)
Housing color	Black (RAL 9004) / White (RAL 9003)
Video input signals	2x DisplayPort 1.4
USB ports	2x USB-B 2.0 upstream (endpoint) 5x USB-A 2.0 downstream (of which 1 charge port)
Power rating	24 VDC, 4 A
Power requirements	This device shall only be powered by the medical approved power supply of Adapter Technology Co., Ltd., type ATM160T-P240. Ratings marked on the power supply: <ul style="list-style-type: none"> • Input: 100-240 VAC, 1.8-0.9 A, 50-60 Hz • Output: 24 VDC, 6.6 A
Power consumption	45 W (nominal) < 0.35 W (hibernate) < 0.30 W (switched off)
Dimensions with stand (W x H x D)	Portrait: 351 x 531~631 x 225 mm Landscape: 491 x 462~562 x 225 mm
Dimensions w/o stand (W x H x D)	Portrait: 351 x 491 x 64 mm Landscape: 491 x 351 x 64 mm
Dimensions packaged (W x H x D)	455 x 210 x 770 mm
Net weight with stand	MDNC-3521 SPES: 8.8 kg MDNC-3521 SNES: 7.7 kg
Net weight w/o stand	MDNC-3521 SPES: 5.8 kg MDNC-3521 SNES: 4.7 kg
Net weight packaged	MDNC-3521 SPES: 12.2 kg (without optional accessories) MDNC-3521 SNES: 11.2 kg (without optional accessories)
Tilt	-10° to +30°
Swivel	-30° to +30°
Pivot	90°

Height adjustment range	100 mm
Mounting standard	VESA (100 mm)
Screen protection	MDNC-3521 SPES: Protective, anti-reflective front glass MDNC-3521 SNES: N/A
Recommended modalities	All digital images, except digital mammography
Certifications*	<p>CE0123 (Medical Device) FDA 510(k) K230520 CCC (China), KC (Korea), BSMI (Taiwan), INMETRO (Brazil - Product numbers K9300390A, K9300391A) BIS (India), EAC (Russia, Kazakhstan, Belarus, Armenia and Kyrgyzstan)</p> <p>Safety specific:</p> <ul style="list-style-type: none"> • IEC 60950-1:2005 + A1:2009 • EN 60950-1:2006 + A1:2010 + A11:2009 + A12:2011 + A2:2013 • IEC 62368-1:2018 • EN IEC 62368-1:2020 • IEC 60601-1:2005 + A1:2012 • EN 60601-1:2006 + A1:2013 + A12:2014 • ANSI/AAMI ES 60601-1:2005 + R1:2012 • CAN/CSA C22.2 No. 60601-1:2014 <p>EMI specific:</p> <ul style="list-style-type: none"> • IEC 60601-1-2:2014 (ed4) • EN 60601-1-2:2015 (ed4) • FCC part 15 Class B • ICES-001 Level B • VCCI (Japan) <p>Environmental: China Energy Label, EU RoHS, China RoHS, REACH, Canada Health, WEEE, Packaging Directive</p> <p>*Some of the listed certifications may still be pending. For the actual list of applicable certifications, please refer to the product page on www.barco.com or see the certification marks on the product label of your display.</p>
Supplied accessories	<ul style="list-style-type: none"> • User Guide • Documentation disc • System sheet • Video cables • Mains cable(s) • USB cable • External power supply
Optional accessories	Display controller
QA software	QAWeb Enterprise
Warranty	5 years, including 20000 hours backlight warranty
Operating temperature	0 °C to 35 °C (20 °C to 30 °C within specs)
Storage temperature	-20 °C to 60 °C
Operating humidity	8 % to 80 % (non-condensing)
Storage humidity	5 % to 85 % (non-condensing)
Operating pressure	70 kPa minimum
Storage pressure	50 to 106 kPa

CE
0123



Barco NV
President Kennedypark 35
8500 Kortrijk
Belgium



R5915130 /06 | 2023-11-14

www.barco.com